



TECHNICAL BULLETIN }  
 No. MED 524 }

HEADQUARTERS  
 DEPARTMENT OF THE ARMY  
 WASHINGTON, DC, 20 June 1985

# OCCUPATIONAL AND ENVIRONMENTAL HEALTH

## CONTROL OF HAZARDS TO HEALTH FROM LASER RADIATION

		Paragraph	Page
CHAPTER 1.	INTRODUCTION		
	Purpose .....	1-1	1-1
	References .....	1-2	1-1
	Explanation of abbreviations and terms .....	1-3	1-1
	Responsibilities .....	1-4	1-1
	Background information .....	1-5	1-1
CHAPTER 2.	EFFECTS OF LASER EXPOSURE		
Section I.	Biologic Effects		
	General .....	2-1	2-1
	Skin .....	2-2	2-1
	Eye .....	2-3	2-1
Section II.	Medical Surveillance		
	Personnel to be examined .....	2-4	2-2
	Examination requirements .....	2-5	2-2
	Accident reporting procedures .....	2-6	2-2
Section III.	Protection Standards		
	General .....	2-7	2-3
CHAPTER 3.	HAZARDS OF LASER APPLICATION		
Section I.	Evaluation of Hazards		
	General procedure .....	3-1	3-1
	Laser and laser system hazard classification scheme .....	3-2	3-1
	Environment .....	3-3	3-1
Section II.	Hazard Controls for Laser Radiation		
	General .....	3-4	3-3
	Outdoor laser installations .....	3-5	3-3
	Indoor laser installations .....	3-6	3-3
	Warning signs and labels .....	3-7	3-4
Section III.	Recognition of Associated Hazards		
	Atmospheric contamination .....	3-8	3-7
	Ultraviolet radiation .....	3-9	3-7
	Visible and near-infrared radiation .....	3-10	3-7
	Electrical hazards .....	3-11	3-7
	Cryogenic coolants .....	3-12	3-7
	Other hazards .....	3-13	3-7
	X-rays .....	3-14	3-7
Section IV.	Simplified Range Control Measures for Typical Operations of Laser Rangefinders and Designators		
	Limitations .....	3-15	3-7
	Background .....	3-16	3-7
	Laser instruction .....	3-17	3-8
	Range control procedures .....	3-18	3-9
	Range boundaries .....	3-19	3-9
	Optical instruments .....	3-20	3-10
	Warning signs .....	3-21	3-10
	Approved targets .....	3-22	3-11
	Eye protection .....	3-23	3-11
	Countdown .....	3-24	3-12
	Weather and environmental conditions .....	3-25	3-12
	Operation outside of range area .....	3-26	3-12

\*This bulletin supersedes TB MED 279, 30 May 1975.

	Paragraph	Page
Laser operations from aircraft .....	3-27	3-12
Laser safety output attenuators.....	3-28	3-13
Hangar, garage, and maintenance shop procedures .....	3-29	3-13
 CHAPTER 4. PERSONAL PROTECTIVE EQUIPMENT		
Eye protection .....	4-1	4-1
Skin protection.....	4-2	4-1
Low temperature protection.....	4-3	4-1
 CHAPTER 5. ADMINISTRATION		
Accident reporting.....	5-1	5-1
Biological data .....	5-2	5-1
Technical assistance .....	5-3	5-1
 APPENDIX A. REFERENCES.....		A-1
B. INTRODUCTION TO LASERS .....		B-1
C. LASER EXPOSURE LIMITS.....		C-1
D. LASER HAZARD CLASSIFICATION.....		D-1
E. DETAILED TECHNICAL HAZARD ANALYSIS .....		E-1
F. LASER PROTECTIVE EYEWEAR.....		F-1
G. FIRST AID PROCEDURES FOR INCLUSION IN LASER SOPs .....		G-1
 GLOSSARY .....		Glossary 1

List of Tables

No.	Title	Page
2-1	Protection standards for typical lasers .....	2-3
3-1	Buffer zone values for currently fielded equipment .....	3-8
3-2	Protective eyewear data .....	3-12
4-1	Simplified method for selecting laser eye protection for intrabeam viewing for wavelengths between 400 and 1400 nm .....	4-2
C-1	Exposure limits for direct ocular exposures (intrabeam viewing) from a laser beam.....	C-2
C-2	Exposure limits for viewing a diffuse reflection of a laser beam or an extended source laser .....	C-3
C-3	Exposure limits for skin exposure from a laser beam .....	C-3
D-1	Maximum allowable radiant intensity from a diffuse surface reflection as measured at the reflecting surface for extended sources: angular subtense $\alpha_{\min}$ .....	D-2
D-2	Typical laser classification—CW lasers .....	D-2
D-3	Typical laser classification—single pulse lasers .....	D-3
E-1	Atmospherically corrected values of NOHD when the NOHD, with or without optics in vacuum, is known [NOHD(v)].....	E-12

List of Figures

2-1	Absorption of electromagnetic radiation by the eye.....	2-1
3-1	Diffuse reflection and specular reflection .....	3-2
3-2	Specular reflection from pond of water or horizontal flat glass on range .....	3-2
3-3	Class 2 laser warning label .....	3-4
3-4	Class 3a laser warning label .....	3-5
3-5	Class 3b or 4 laser warning label .....	3-5
3-6	Class 3b or Class 4 laser controlled area warning sign .....	3-6
3-7	Example of European warning labels .....	3-6
3-8	Laser range terrain profiles with backstops .....	3-9
3-9	Laser safety danger zones .....	3-11
3-10	Maintenance test range.....	3-13
B-1	The electromagnetic spectrum.....	B-1
B-2	Emission of radiation by transition of an electron from a higher energy state to a lower energy state .....	B-2
B-3	Three-level energy diagram .....	B-2
B-4	Population inversion.....	B-3
B-5	Three typical optical cavities .....	B-3
B-6	Schematic of solid-state laser with optical pumping .....	B-4
B-7	Schematic of helium-neon laser with electron collision pumping (representative of small gas lasers) .....	B-4
B-8	Schematic of CO <sub>2</sub> gas transport laser (GTL) .....	B-5

## List of Figures

	Page
B-9 Schematic of gallium-arsenide laser with direct-current (electron collision) pumping (representative of semiconductor or injection lasers) .....	B-5
B-10 Schematic of a liquid dye laser with optical pumping .....	B-6
B-11 Common TEM modes .....	B-7
B-12 Irradiance or radiant exposure at various points in the beam cross-section .....	B-7
B-13 Definition of divergence angle .....	B-7
C-1a Protection standard for intrabeam viewing of pulsed visible (400-700 nm) laser radiation .....	C-4
C-1b Exposure limit for intrabeam viewing of CW visible (400-700 nm) and IR-A (750, 900, and 1060-1400 nm) laser radiation....	C-5
C-2a Exposure limit for extended sources or diffuse reflections of pulsed laser radiation (400-700 nm) .....	C-6
C-2b Exposure limit for extended sources or diffuse reflections of CW visible (400-700 nm) and IR-A (850, 900, and 1060-1400 nm) laser radiation .....	C-7
C-3 Limiting angular subtense of an extended source ( $\alpha_{min}$ ) .....	C-8
C-4 Correction factor $C_A$ for wavelengths 0.7-1.4 $\mu$ m .....	C-8
C-5 Correction factor $C_p$ for repetitively pulsed lasers having pulse durations less than $10^{-5}$ second .....	C-9
C-6a Exposure limit for pulsed laser exposure of skin and eyes for far-infrared radiation (wavelengths greater than 1400 nm) .....	C-9
C-6b Exposure limit for CW laser exposure of skin and eyes for far-infrared radiation (wavelengths greater than 1400 nm) ..	C-10
C-7 Correction factors $C_B$ and $T_1$ for wavelengths 0.55-0.7 $\mu$ m .....	C-10
E-1 Specular reflectance from both surfaces of plate glass having an index of refraction of 1.5 .....	E-1
E-2 Hazard envelopes created by a laser beam incident upon a vertically oriented flat glass surface .....	E-1
E-3 Intrabeam viewing—direct beam (primary beam) .....	E-3
E-4a Intrabeam viewing—specularly reflected from <i>flat</i> surface (secondary beam) .....	E-3
E-4b Intrabeam viewing—specularly reflected from <i>curved</i> surface (secondary beam) .....	E-3
E-5 Extended source viewing—normally a diffuse reflection .....	E-3
E-6 Fraction of a Gaussian laser beam passing through a circular aperture .....	E-9
F-1 Photopic (day vision) and scotopic (night vision) visual response .....	F-2

## CHAPTER 1

## INTRODUCTION

**1-1. Purpose.** *a.* This bulletin provides guidelines and establishes responsibilities for personnel protection from laser radiations within the framework of currently documented experimental evidence. Medical guidance is limited by the biologic data available. This bulletin encompasses the portion of the electromagnetic spectrum that includes ultraviolet, visible light, and infrared in which laser radiation can be produced. It applies to those activities established and operated at active Army, US Army National Guard, US Army Reserve, and Corps of Engineers facilities.

*b.* Provisions of this publication are subject to three international standardization agreements: STANAG 3606 LAS (Edition No. 4)—EVALUATION AND CONTROL OF LASER HAZARDS, STANAG-2900 (MED)—LASER RADIATION—MEDICAL SURVEILLANCE AND EVALUATION OF OVER-EXPOSURE, and STANAG 3828—EYE PROTECTION—AIR CREWS. When an amendment, revision or cancellation of this bulletin is proposed that will affect or violate the agreement concerned, the preparing activity will take proper action through international standardization channels.

**1-2. References.** Required and related publications are listed in appendix A.

**1-3. Explanation of Abbreviations and Terms.** Abbreviations and special terms used in this bulletin are explained in the glossary.

**1-4. Responsibilities.** *a.* *The Surgeon General* will evaluate potential health hazards to personnel operating, testing, or associated with lasers (AR 10-5, para 2-34).

*b.* *The Installation Medical Authority (IMA)* will insure that—

(1) Eye examinations are performed on required personnel prior to or upon termination of employment with eye hazardous laser or optical sources (see para 2-4).

(2) Those personnel requiring a preplacement and termination eye examination are included in the Occupational Vision Program per TB MED 506 (see para 2-5a).

(3) Eye examinations by an ophthalmologist or optometrist are performed on persons suspected or confirmed to be exposed to levels of optical radiation in excess of those set in AR 40-46, chapter 2 (see para 2-7).

*c.* *The Commander, US Army Environmental Hygiene Agency (USAEHA)* will—

(1) Provide a team to investigate a suspected or confirmed exposure to nonionizing radiation when directed to do so by The Surgeon General.

(2) Establish the nominal ocular hazard distances (NOHDs) of the standard field lasers.

*d.* *The Commander, Letterman Army Institute of Research (LAIR)* will conduct research and development to obtain data on biomedical effects of laser radiation.

*e.* *Installation commanders* will perform responsibilities set up in AR 40-5 and AR 385-63, paragraph 19-4d.

*f.* *Command safety manager* will perform responsibilities set up in AR 385-9 and AR 385-63, paragraph 19-4e.

*g.* *Firing/lasing unit commanders* will perform responsibilities set up in AR 40-46 and AR 385-63, paragraph 19-4f.

*h.* *The laser range safety officer/noncommissioned officer (LRSO/LRNCO)* will insure that—

(1) All personnel authorized to participate in the laser operation are thoroughly instructed regarding safety precautions to be followed.

(2) Safe standing operating procedures (SOPs) are implemented (app G). Specifically—

(a) Insure that established target areas, with buffer zones around the target area as defined by the greatest laser-to-target distance, are observed.

(b) Provide adequate surveillance of the target area to insure that unauthorized personnel do not enter the target area.

(c) Insure that communication with personnel in the target area is maintained and that required protective eyewear is worn during the operation of the laser system.

**WARNING**

Any break in communication or entrance of unprotected personnel into the laser surface danger zone will automatically terminate the laser operation.

(d) Report immediately any case of suspected overexposure of the eyes to laser radiation to the IMA so that an eye examination can be performed within 24 hours of the exposure.

**1-5. Background Information.** *a.* The term LASER is an acronym derived from *Light Amplification by Stimulated Emission of Radiation*. The effects of la-

ser radiation are essentially the same as optical radiation which is generated by more conventional ultraviolet, infrared, and visible optical sources. The biological implications attributed to laser radiation usually result from the very high beam collimation, beam intensities, and monochromaticity of many lasers. Lasers differ from conventional sources of optical radiation primarily in their ability to attain highly coherent radiation (light waves in phase). The increased directional intensity of the optical radiation generated by a laser results in concentrated optical beam irradiances at considerable distances. A short summary of types of lasers and their characteristics is provided in appendix B.

b. Recent developments in laser technology have resulted in an increase in the use of these devices for military research and field use. Field military lasers

are used principally for target acquisition, training, and fire control. The widespread use of laser systems increases the probability of personnel exposure to injurious levels of laser radiation. Although lasers have characteristics that can be used to good advantage, they are potentially hazardous and adequate safeguards must be provided.

c. The evaluation of laser hazards can be highly technical. In the interest of simplifying the task of developing range controls in the field, this bulletin is organized with practical guidance for recognizing associated hazards (paras 3-8 through 3-14). More specialized information may be found in paragraphs 2-7 and 3-1 through 3-7. Detailed technical information for highly specialized laser applications may be found in appendixes C, D, E, and F.

## CHAPTER 2

## EFFECTS OF LASER EXPOSURE

## Section I. BIOLOGIC EFFECTS

2-1. **General.** Laser radiation should not be confused with ionizing radiation (such as X and gamma rays) although very high irradiances have been known to produce ionization in air and other materials. The biologic effects of laser radiation are essentially those of visible, ultraviolet, or infrared radiation upon tissues. However, radiant intensities typically produced by lasers are of magnitudes that could previously be approached only by the sun, nuclear weapons, burning magnesium, or arc lights. This is one of the important properties that make lasers potentially hazardous. Laser radiation incident upon biologic tissue will be reflected, transmitted, and/or absorbed. The degree to which each of these effects occurs depends upon various properties of the tissue involved. Absorption is selective: as in the case of visible light, darker material such as melanin or other pigmented tissue absorbs more energy.

2-2. **Skin.** Adverse thermal effects resulting from exposure of the skin to radiation from 315 nm to 1mm may vary from mild reddening (erythema) to blistering and charring. This depends upon the exposure dose rate, the dose (amount of energy) transferred, and the conduction of heat away from the absorption site. Adverse skin effects resulting from exposure to actinic ultraviolet radiation (180 to 315 nanometers (nm)) vary from erythema to blistering, depending upon the wavelength and total exposure dose.

2-3. **Eye.***a. General.*

(1) In almost all situations the eye is the organ most vulnerable to injury. Figure 2-1 provides a schematic representation of absorption of electromagnetic radiation by the eye:

(a) Most higher energy X-rays and gamma rays pass completely through the eye with relatively little absorption.

(b) Absorption of short-ultraviolet (UV-B and UV-C) and far-infrared (IR-B and IR-C) radiation occurs principally at the cornea.

(c) Near ultraviolet (UV-A) radiation is primarily absorbed in the lens.

(d) Light is refracted at the cornea and lens and absorbed at the retina; near infrared (infrared-"A") (IR-A) radiation is also refracted and is absorbed in the ocular media and at the retina.

(2) Refer to paragraph 3-23 for a discussion on laser protective eyewear.

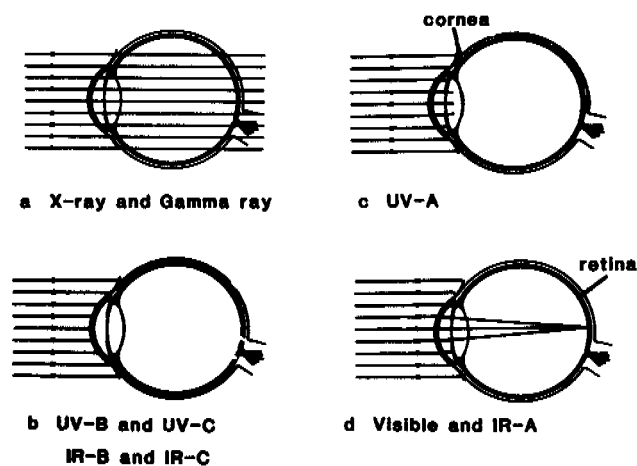

Figure 2-1. Absorption of electromagnetic radiation by the eye.

*b. Light (400-760 nm) and near-infrared (IR-A) radiation (>760-1400 nm) (fig 2-1d).* Adverse laser effects are generally believed to be limited largely to the retina in this spectral region. The effect upon the retina may be a temporary reaction without residual pathologic changes, or it may be more severe with permanent pathologic changes resulting in a permanent scotoma. The mildest observable reaction may be simple reddening; but, as the retinal irradiance is increased, lesions may occur which progress in severity from edema to charring, with hemorrhage and additional tissue reaction around the lesion. Very high radiant exposures will cause gases to form near the site of absorption which may disrupt the retina and may alter the physical structure of the eye. Portions of the eye other than the retina may be selectively injured, depending upon the region where the greatest absorption of the specific wavelength of the laser energy occurs and the relative sensitivity of tissue affected. Chronic low-level exposure to blue light at wavelengths less than 520 nm may produce some photochemical retinal damage.

*c. Ultraviolet radiation (180-400 nm) (fig 2-1, items b and c.)* Actinic ultraviolet radiation, UV-B and UV-C (180-315 nm), can produce symptoms similar to those observed in arc welders. It may cause severe acute inflammation of the eye and conjunctiva. UV-B and UV-C radiation does not reach the retina. Near ultraviolet radiation (UV-A) is absorbed principally in the lens which causes the lens to fluoresce. Very high doses can cause corneal and lenticular opacities. Insignificant levels of UV-A reach the retina.

*d. Far-infrared radiation, IR-B and IR-C, (1.4-1000 micrometers ( $\mu\text{m}$ )) (fig 2-1, item b).* Absorption of far-infrared radiation produces heat with its characteristic effect on the cornea and the lens of the eye.

The 10.6- $\mu\text{m}$  wavelength from the carbon-dioxide laser is absorbed by the cornea and conjunctiva and may cause severe pain and destructive effects.

## Section II. MEDICAL SURVEILLANCE

**2-4. Personnel to be Examined.** Personnel with a significant risk of exposure to hazardous levels (i.e., greater than the occupational exposure limits) of ultraviolet, visible, or infrared radiation shall have a preplacement and termination ocular surveillance examination and be included in an Occupational Vision Program for biennial vision screening examinations. The following personnel should receive ocular surveillance examinations:

*a.* Individuals *routinely* using Class 3 or Class 4 lasers in any research, development, testing, and evaluation (RDTE) effort, where adequate protective measures are not feasible. Personnel involved in only one test of short duration would not normally receive preplacement or termination ocular examinations, but would be examined only if injury was suspected.

*b.* Certain laser equipment, such as tripod-mounted, hand-held or airborne laser rangefinders, designators, or illuminators may be determined to present a sufficient hazard to operators and related personnel that such personnel may be required by The Surgeon General to be examined. The warning page of the operator's and maintenance manuals for each laser device shall indicate which types of user or related personnel should be examined. Operators of currently fielded tactical laser systems listed in table 3-1 are *not* required to receive this eye examination.

*c.* Maintenance personnel *routinely* working with high intensity search lights or laser rangefinders, illuminators, and designators.

*d.* Operators and maintenance personnel routinely working with Class 3 engineering laser transits, geodimeters, and alignment devices.

### WARNING

Visitors shall be adequately protected from the laser beam by protective devices and should not receive ocular surveillance examinations unless injury is suspected.

**2-5. Examination Requirements.** *a. Preplacement and termination examinations.* The preplacement ocular surveillance examination shall be performed prior to assignment to duties involving a significant risk of exposure to hazardous levels of laser or high intensity optical radiation. A termination examination shall be completed as soon as practical subse-

quent to termination of duties with laser or high intensity optical sources.

*b. Periodic examinations.* Laser personnel should be included in an occupational vision program and receive biennial vision screening examinations.

*c. Examination procedures.* The ocular surveillance examination shall be performed by an ophthalmologist, optometrist, or physician skilled in funduscopy and biomicroscopy of the eye and shall include—

(1) An ocular history with special emphasis on photosensitizing drugs, unusual sensitivity to sunlight, or lens surgery.

(2) Visual acuity of each eye (far and near). If less than 20/20, the best acuity shall be refractively determined.

(3) An examination of the retina with the pupil dilated.

(4) A slit lamp (biomicroscopic) examination of the cornea and lens with the pupil dilated.

(5) Amsler grid testing of each eye.

(6) A careful description, drawing, or photograph of any abnormality. The results of these examinations shall be properly recorded in the patients medical record.

*d. Accident examinations.* Suspected or confirmed exposure of the eyes to levels in excess of the occupational exposure limit shall have an immediate (i.e., within 24 hours of exposure) ocular examination by an ophthalmologist or optometrist. This examination should include those procedures for preplacement and termination ocular surveillance examinations, as well as other tests deemed necessary by the examining ophthalmologist or optometrist.

**2-6. Accident Reporting Procedures.** *a.* Laser accident reporting procedures are in AR 40-400, chapter 6, and AR 385-40, paragraph 9-2.

(1) The Special Telegraphic Report of Selected Diseases, RCS MED-16, shall be filed within 5 working days of the suspected or confirmed incident of exposure to radiation in excess of levels set in AR 40-46, chapter 2.

(2) Within 72 hours after the accident, the RCS DD-AE(AR) 1168 shall be reported by message using the format for the Report of Serious Accident in AR



385-40, appendix B. Addressees will consist of HQDA (DASG-PSP) WASH DC 20310-2300, HQDA (DAPE-HRS), WASH DC 20310-0300, and Commander, AMC (AMCSF-P), 5001 Eisenhower Avenue, Alexandria, VA 22333-0001.

b. A representative of either the Occupational and Environmental Medicine Division (AUTOVON 584-

3030) or the Laser Microwave Division (AUTOVON 584-3932), USAEHA, should be consulted immediately upon suspicion or confirmation of an exposure incident. If an incident occurs during nonduty hours, call AUTOVON 584-4375.

### **Section III. PROTECTION STANDARDS**

2-7. **General.** A complete listing of exposure limits for the maximum permissible exposure of the eye and skin specified in AR 40-46 are provided in ap-

pendix C. Exposure limits commonly required for the evaluation of lasers used in military applications are given in table 2-1.

Table 2-1. Protection Standards for Typical Lasers.

Type of laser	PRF	Wavelength	Exposure duration	Exposure limit for intrabeam viewing by the eye
Single Pulse Ruby LRF	Single Pulse	694.3 nm	1 ns-18 $\mu$ s	$0.5 \mu\text{J}\cdot\text{cm}^{-2}$
Single Pulse Neodymium YAG LRF	Single Pulse	1064 nm	1 ns-50 $\mu$ s	$5.0 \mu\text{J}\cdot\text{cm}^{-2}$
Repetitively Pulsed Neodymium YAG LRF and Designators	10 Hz	1064 nm	1 ns-50 $\mu$ s	$1.6 \mu\text{J}\cdot\text{cm}^{-2}$ per pulse
	20 Hz	1064 nm	1 ns-50 $\mu$ s	$1.1 \mu\text{J}\cdot\text{cm}^{-2}$ per pulse
CW Argon Lasers	CW	488 nm & 514.5 nm	0.25 s	$2.5 \text{mW}\cdot\text{cm}^{-2}$
CW Argon Lasers	CW	488 nm & 514.5 nm	4 to 8 hrs	$1.0 \mu\text{W}\cdot\text{cm}^{-2}$
CW Helium-Neon Lasers (for Alignment, etc.)	CW	632.8 nm	0.25 s	$2.5 \text{mW}\cdot\text{cm}^{-2}$
			1 to 8 hrs	$17 \mu\text{W}\cdot\text{cm}^{-2}$
CW Neodymium YAG Laser	CW	1064 nm	1000 s-8 hrs	$1.6 \text{mW}\cdot\text{cm}^{-2}$
Erbium/Glass LRF or Designator	Single Pulse	1540 nm	<1 $\mu$ s	$1.0 \text{J}\cdot\text{cm}^{-2}$
Holmium YHrium Lithium Fluoride (H <sub>2</sub> :YLF)	Single Pulse	2060 nm	1 n-100 ns	$10 \text{mJ}\cdot\text{cm}^{-2}$
Erbium:YLF	Single Pulse	1730 nm	1 n-100 ns	$10 \text{mJ}\cdot\text{cm}^{-2}$
CW Carbon-Dioxide Laser	CW	10.6 $\mu$ m	10 s-8 hrs	$0.1 \text{W}\cdot\text{cm}^{-2}$
CW Carbon-Monoxide Laser	CW	4.7 $\mu$ m	10 s-8 hrs	$0.1 \text{W}\cdot\text{cm}^{-2}$
Single Pulse Carbon-Dioxide LRF	Single Pulse	10.6 $\mu$ m	1 ns-100 ns	$10 \text{mJ}\cdot\text{cm}^{-2}$

## CHAPTER 3

## HAZARDS OF LASER APPLICATION

## Section I. EVALUATION OF HAZARDS

**3-1. General Procedure.** Three aspects of a laser application influence the total hazard evaluation and thereby influence the application of control measures. These are the—

- a. Laser device's capability of injuring personnel.
- b. Environment in which the laser is used.
- c. Personnel who may be exposed.

A practical means for both evaluation and control of laser radiation hazards is to first classify laser devices according to their relative hazards and then to specify approximate controls for each classification. The use of the hazard classification method will in most cases preclude any requirement for laser measurements and greatly reduce the need for calculations. This standardized laser hazard classification scheme defines *aspect 1* as the potential hazard of the laser device. *Aspects 2* and *3* vary with each laser application and cannot be readily included in a general hazard classification scheme. The total hazard evaluation procedure must consider all three aspects, although in most cases only *aspect 1* influences the control measures that are applicable.

**3-2. Laser and Laser System Hazard Classification Scheme.** *a.* The four hazard classifications are defined by the laser output parameters and are specified in detail in appendix D. The general classification scheme with general hazard control concepts follows:

(1) Class 1 laser devices are those *not* capable of emitting hazardous laser radiation under any operating or viewing condition.

(2) Class 2 laser devices are continuous wave (CW) visible (400 to 700 nm) laser devices. Precautions are required to prevent continuous staring into the direct beam; momentary (>0.25 sec) exposure occurring in an unintentional viewing situation is not considered hazardous.

(3) Class 3b laser devices are potentially hazardous if the direct or specularly reflected beam is viewed by the unprotected eye, but do not (unless focused) cause hazardous diffuse reflections. Care is required to prevent intrabeam viewing and to control specular reflections. Class 3a lasers are normally not hazardous unless viewed with magnifying optics from within the beam.

(4) Class 4 lasers are those pulsed visible and near-infrared lasers capable of producing diffuse reflections, fire and skin hazards, or those lasers with an average output power of 500 milliwatts (mW) or

greater. Safety precautions associated with Class 4 lasers generally consist of using door interlocks to prevent exposure to unauthorized or transient personnel entering the laser facility; the use of baffles to terminate the primary and secondary beams; and the wearing of protective eyewear and clothing by personnel.

*b.* This classification scheme is identical to that used in American National Standards Institute (ANSI) Standard ANSI-Z-136 and virtually identical to the Federal product performance standards in part 1040, title 21, Code of Federal Regulations (21 CFR 1040). This classification already appears on commercial laser products manufactured after July 1976 and should be used unless the laser is modified to significantly change its output power or energy, or unless the laser is enclosed.

**3-3. Environment.** Following the laser system hazard classification, environmental factors require consideration. Their importance in the total hazard evaluation depends upon the laser hazard classification. The decision to employ additional hazard controls not specifically required in paragraphs 3-2*a*(3) and (4) for Class 3 and Class 4 laser devices depends largely on environmental considerations. The probability of personnel exposure to hazardous laser radiation will be considered and is influenced by whether the laser is used indoors, like: in a machine shop, in a classroom, in a research laboratory, or a factory production line; or outdoors, like: on a range, in the atmosphere above occupied areas, or in a pipeline construction trench. Other environmental hazards (sec III) shall be considered. If exposure of unprotected personnel to the primary or specularly reflected beam is expected, calculations or measurements of either irradiance or radiant exposure of the primary or specularly reflected beam (or radiance of an extended source laser) at that specific location are required. These detailed procedures are discussed in appendix E.

*a. Indoor laser operations.* In general, only the laser device classification is considered in evaluating an indoor laser operation if the beam is enclosed or is operated in a controlled area. The following step-by-step procedure is recommended for evaluation of indoor Class 3 lasers when this is necessary (since there is a potential exposure of unprotected personnel with this particular class of laser devices).

(1) *STEP 1.* Determine the hazardous beam path(s).

(2) *STEP 2.* Determine the extent of hazardous specular reflection, as from lens surfaces and beam splitters (app E).

(3) *STEP 3.* Determine the extent of hazardous diffuse reflections if the emergent laser beam is focused.

(4) *STEP 4.* Determine if other (nonlaser) hazards exist (sec III).

*b. Outdoor laser operations over extended distances.* The total hazard evaluation of a particular laser system depends on defining the extent of several potentially hazardous conditions. This may be done in a step-by-step manner as follows:

(1) *STEP 1.* Determine the NOHD of the laser (app E). The NOHD of standard field lasers is established by the USAEHA.

(2) *STEP 2.* Evaluate potential hazards from specular surface reflections, such as those from windows and mirrors in vehicles. Flat surfaces present the greatest problem since specular reflections retain a high collimation of the original laser beam (figs 3-1 and 3-2).

(3) *STEP 3.* Determine whether hazardous diffuse reflections exist if the laser is operating in the 400-1400 nm band (table C-2 and example 9, app E).

(4) *STEP 4.* Evaluate the stability of the laser platform. Determine the extent of lateral range control and the lateral constraints that should be placed upon the beam traverse. Evaluate the need for the control of the elevation angle.

(5) *STEP 5.* Determine the likelihood of personnel being present in the area of the laser beam.

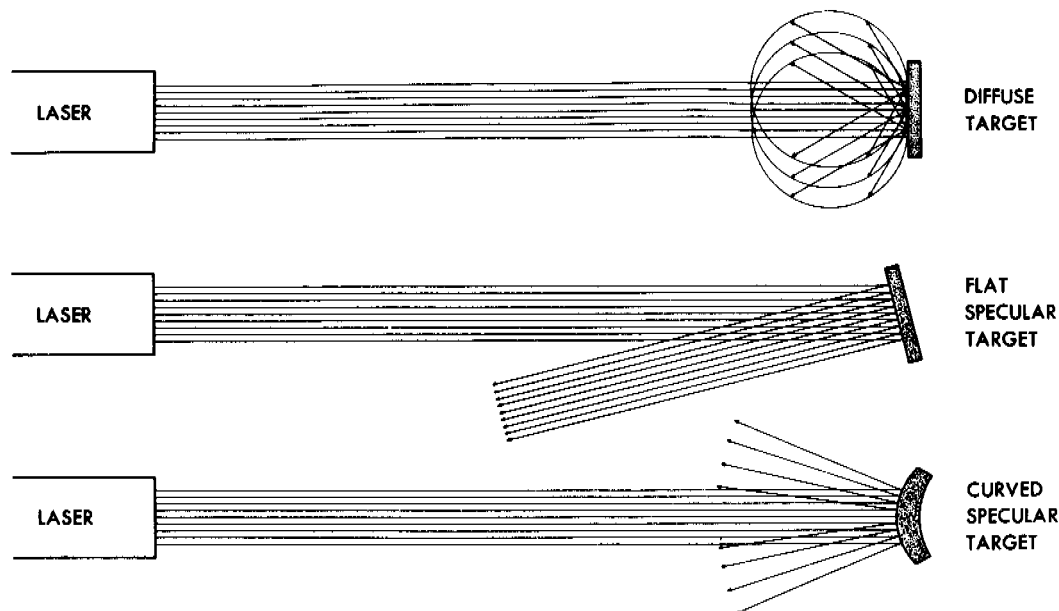

Figure 3-1. Diffuse reflection and specular reflection.

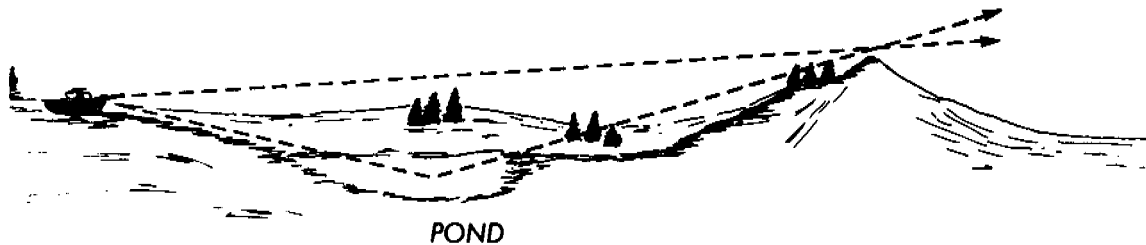

Figure 3-2. Specular reflection from pond of water or horizontal flat glass on range.

*c. Personnel.*

(1) The individuals who may be in the vicinity of a laser and its emitted beam(s) can influence the decision to adopt additional control measures not

specifically required for the Class of laser being employed. Specifically—

(a) If children or others unable to read or understand warning labels may be exposed to poten-

tially hazardous laser radiation, the hazard evaluation is affected. Control measures could require appropriate modification.

(b) The type of personnel influences the total hazard evaluation (principally with the use of Class 3 lasers). Keep in mind that for laser rangefinders, designators, and some Class 3 lasers used in construction, the principal hazard control rests with the operator not to aim the laser at personnel or flat mirror-like surfaces.

(2) The following are considerations to be taken into account regarding personnel who may be exposed:

(a) Maturity and general level of training and

experience of laser user(s) (e.g., trainees, experienced soldiers, scientists).

(b) Potentially hazardous laser radiation may be present and onlookers may not have knowledge of relevant safety precautions.

(c) Degree of training in laser safety of all individuals involved in the laser operation.

(d) Reliability of individuals to wear eye protection, if required.

(e) Laser exposure that may be intentional for the application.

(f) Number and location of individuals relative to the primary beam or reflections, and probability of accidental exposure.

## Section II. HAZARD CONTROLS FOR LASER RADIATION

3-4. **General.** Remember that the hazard classification scheme given in paragraph 3-2 relates specifically to the laser device itself and to its potential hazard based on operating characteristics. However, the environment and conditions under which the laser is used, the safety training of persons using the laser, and other environmental and personnel factors may play a role in determining the full extent of hazard control measures. Since such situations shall require informed judgments by responsible persons, major responsibility for such judgments shall be assigned to a qualified person, namely a laser safety officer. Only properly trained persons shall be designated laser safety officers or be placed in charge of Classes 3 and 4 laser installations or operations. Complete enclosure of a laser beam (an enclosed laser) shall be used when feasible. A closed installation provides the next most desirable hazard control measure. Following are details relating to a safe laser operation in an—

a. Outdoor environment where administrative controls often provide the only reasonable approach.

b. Indoor environment where engineering controls should play the greatest role.

3-5. **Outdoor Laser Installations.** a. *Class 2 laser devices.* The beam will be terminated where readily feasible at the end of the useful beam path, and the laser shall not be directed at personnel who do not expect to be illuminated.

b. *Class 3 and 4 lasers.*

(1) Unprotected personnel shall be excluded from the beam path at all points where the beam irradiance or radiant exposure exceed the appropriate exposure limit. This shall be accomplished by the use of physical barriers, administrative controls, and by limiting the beam traverse.

(2) The tracking of nontarget vehicular traffic or aircraft shall be prohibited.

(3) The target area shall be cleared of all flat specular surfaces capable of producing reflections that are potentially hazardous, or eye protection shall be required for all personnel within the hazardous area.

(4) Sections III and IV provide detailed guidance applicable to range control of laser rangefinders and designators.

c. *Class 4 laser.* Operation of Class 4 laser devices while it is raining or snowing, or when there is dust or fog in the air should be avoided unless laser protective eyewear is worn by personnel within the immediate vicinity of the beam (e.g., within 2-3 ft of the beam path).

3-6. **Indoor Laser Installations.** a. *Class 4 laser installations—specific precautions.* Pulsed Class 4 visible and IR-A lasers are hazardous to the eye from direct beam viewing, and from specular (and sometimes diffuse) reflections of the laser beam. Class 4 ultraviolet, infrared, and CW visible lasers present a potential fire and skin hazard. Safety precautions associated with high-risk lasers generally consist of using door interlocks to prevent exposure to unauthorized or transient personnel entering the controlled facility; the use of baffles to terminate the primary and secondary beams; and the wearing of protective eyewear or clothing by personnel within the interlocked facility.

(1) Safety interlocks at the entrance of the laser facility shall be so constructed that unauthorized or transient personnel shall be denied access to the facility while the laser is capable of emitting laser radiation in excess of Class 4 levels.

(2) Laser electronic-firing systems for pulsed lasers shall be so designed that accidental pulsing of a

stored charge is avoided. The firing circuit design should incorporate a "fail-safe" system in this regard.

(3) An alarm system including a muted sound and/or warning lights (visible through laser protective eyewear) and a countdown procedure should be used once the capacitor banks begin to charge.

(4) Good room illumination is important in areas where laser eye protection is required. Light colored, diffuse surfaces in the room help to achieve this condition.

(5) Very high-energy or high-power lasers should be operated by remote control firing with television monitoring, if feasible. This eliminates the need for personnel to be physically present in the same room. The enclosure of the laser, the associated beam, and the target in a light-tight box is an acceptable alternative.

(6) The principal hazard associated with high-power CW far-infrared (such as carbon dioxide (CO<sub>2</sub>)) lasers is the fire hazard. A sufficient thickness of earth, firebrick, or other fire-resistant materials should be provided as a backstop for the beam.

(7) Reflections of far-infrared laser beams should be attenuated by enclosure of the beam and target area or by eyewear constructed of a material,

such as Plexiglas® which is opaque to laser wavelengths greater than 3 μm. Even dull metal surfaces may be highly specular at far-infrared laser wavelengths such as 10.6 μm (CO<sub>2</sub> laser).

*b. Specific precautions applicable to Class 3 CW or pulsed laser systems.* These lasers are potentially hazardous if the direct or specularly-reflected beam is viewed by the unprotected eye. Care is required to prevent direct beam viewing and control specular reflections. Eye protection may be required if accidental intra-beam viewing is possible.

**3-7. Warning Signs and Labels.** Placarding of potentially hazardous areas should be accomplished according to local SOPs for Class 3 and Class 4 lasers. A warning label shall be affixed permanently to all Class 2, 3, and 4 lasers and laser systems. The signs and labels shown in figures 3-3 through 3-6 are examples. Normally industrial, scientific, and medical laser products manufactured since 1976 already have adequate labeling per 21 CFR 1040. Figure 3-7 depicts two warning labels seen in Europe.

®Plexiglas is a registered trademark of Rohm and Haas Company, Independence Mall West, Philadelphia, PA. Use of trademarked name does not imply indorsement by the US Army, but is intended only to assist in identification of a specific product.

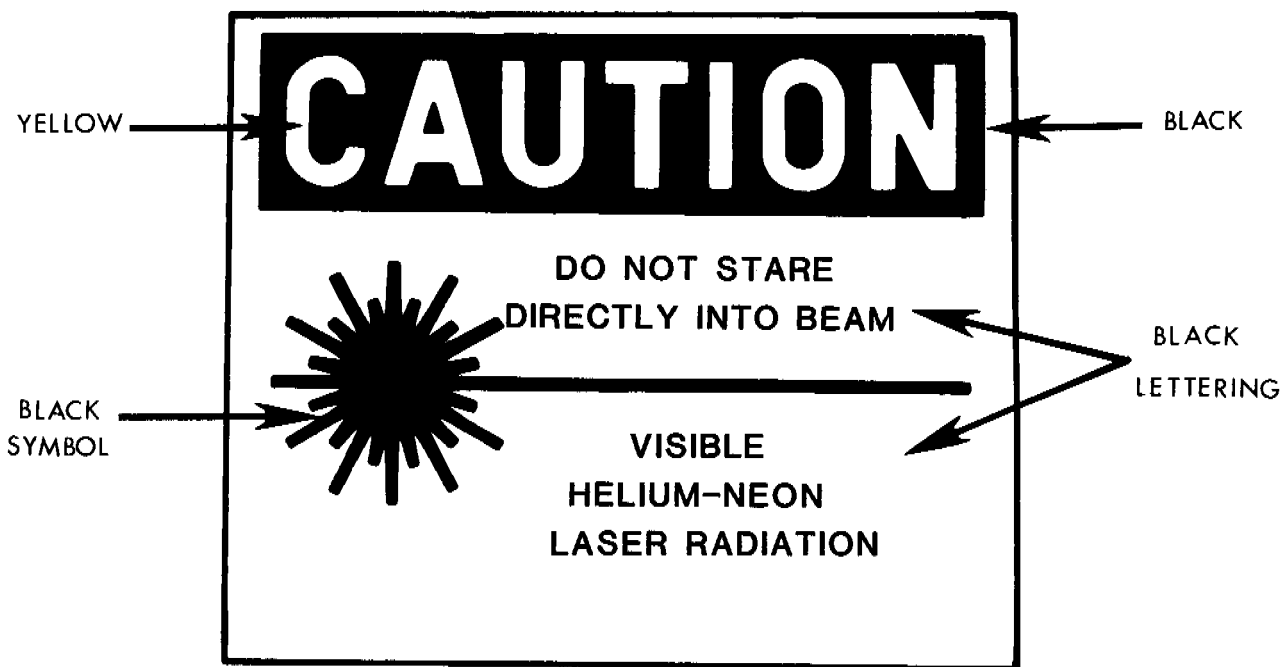

Figure 3-3. Class 2 laser warning label.

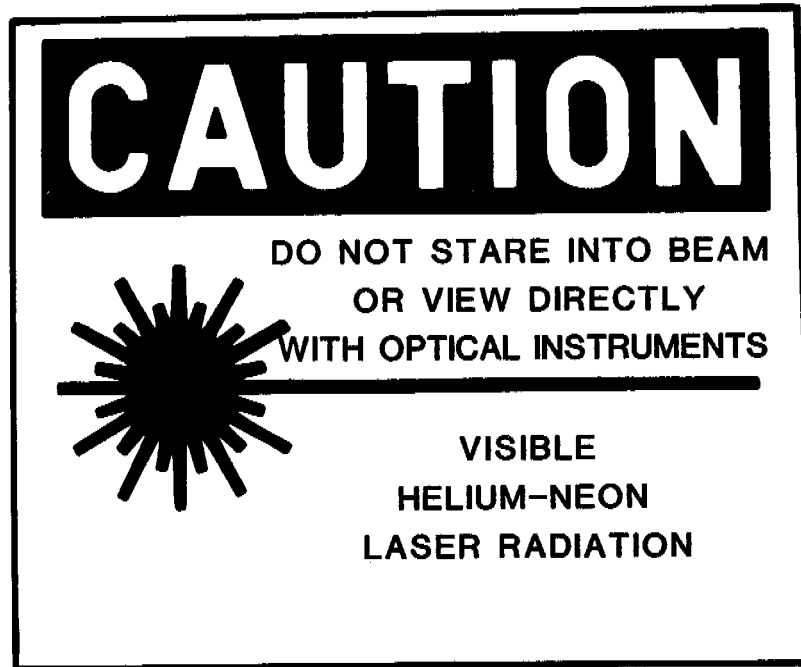

Figure 3-4. Class 3a laser warning label.

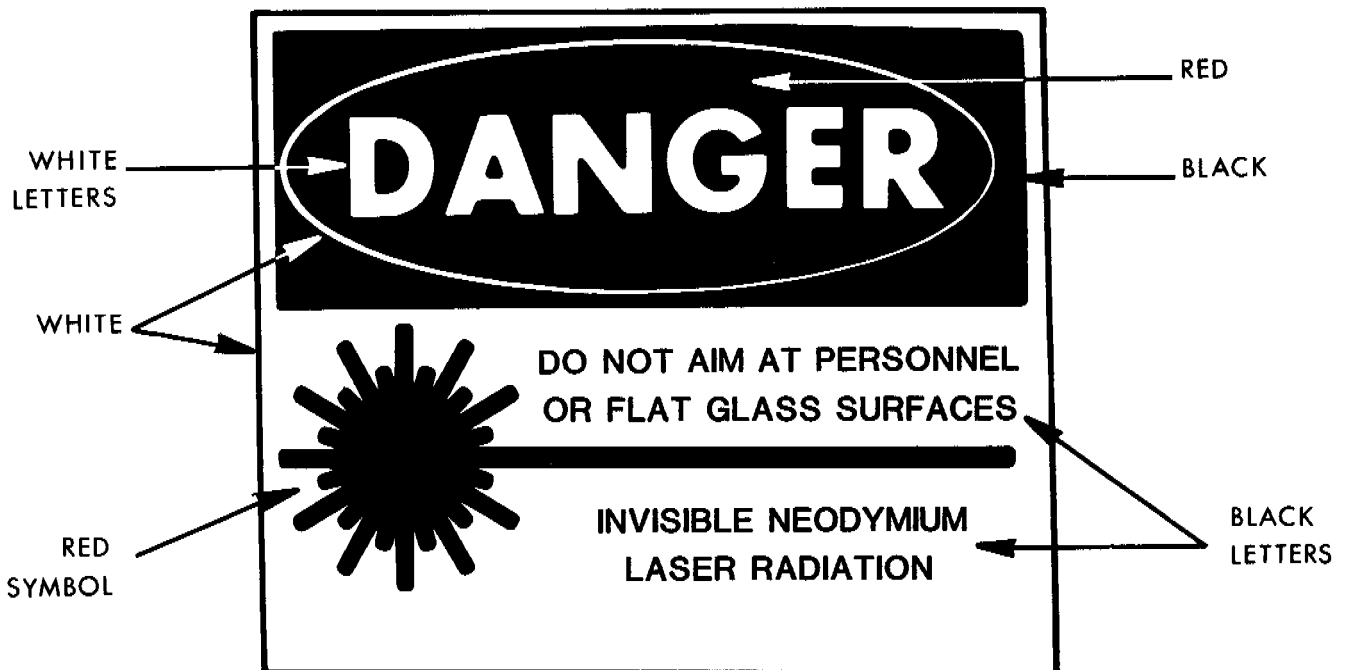

Figure 3-5. Class 3b or 4 laser warning label.



Figure 3-6. Class 3b or Class 4 laser controlled area warning sign.

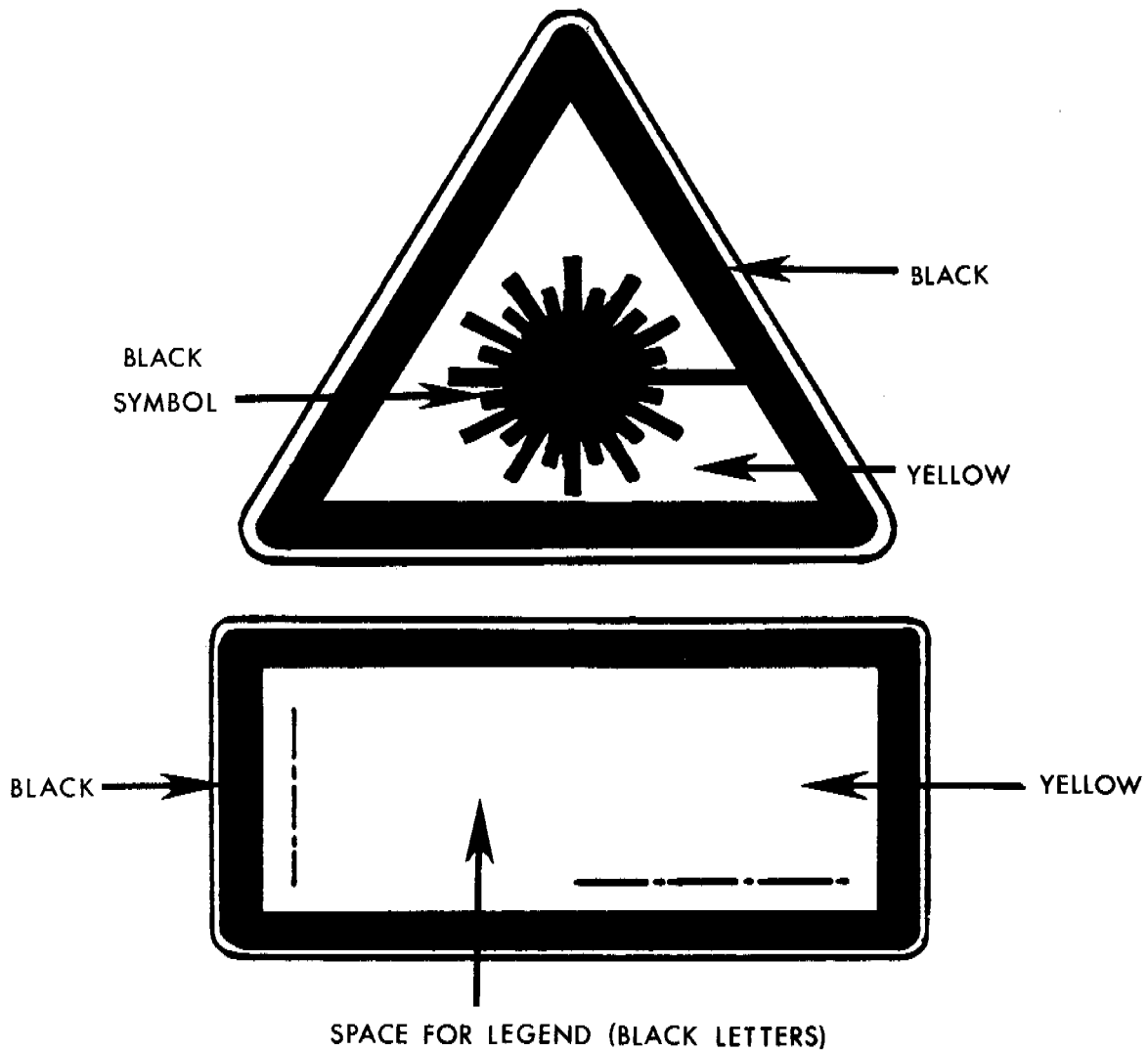

Figure 3-7. Example of European warning labels.



## Section III. RECOGNITION OF ASSOCIATED HAZARDS

**3-8. Atmospheric Contamination.** Adequate ventilation or enclosures shall be employed to control—

*a.* Vaporized target material from high-energy cutting, drilling, and welding operations. Materials involved may include carbon monoxide, carbon dioxide, ozone, lead, mercury, and other metals.

*b.* Gases from flowing gas lasers or byproducts of laser reactions such as bromine, chlorine, hydrogen cyanide, and many others. Ozone created by laser-produced plasma.

*c.* Gases or vapors from cryogenic coolants.

*d.* Vaporized biological target materials from high-energy lasers used in biological or medical applications.

**3-9. Ultraviolet Radiation.** Either direct or reflected ultraviolet (UV) radiation from flash lamps and CW laser discharge tubes should be shielded. UV radiation is generally only of concern when quartz tubing is used. Personnel shall not be exposed to levels of UV radiation in excess of exposure limits given in AR 40-46.

**3-10. Visible and Near-infrared Radiation.** High-intensity optical pumping systems may present a potential retinal hazard and should be shielded.

**3-11. Electrical Hazards.** The potential for electrical shock is present in most laser systems. Pulsed lasers utilize capacitor banks for energy storage and CW lasers generally have high voltage direct current or radio frequency electrical power supplies. Solid-conductor grounding rods (connected first to a reliable ground) shall be utilized to discharge potentially live circuit points prior to maintenance. Maintenance personnel shall familiarize themselves with the safety procedures provided in the maintenance manual for the device.

**3-12. Cryogenic Coolants.** Cryogenic coolants may cause skin or eye injury if improperly used (e.g., liquid nitrogen, liquid helium, and liquid hydrogen).

**3-13. Other Hazards.** The potential for explosions at capacitor banks or optical pump systems exists during the operation of some high-power lasers or laser systems. The possibility of flying particles from target areas in laser cutting, drilling, and welding operations may exist. Explosive reactions of chemical laser reactants or other gases used within certain laser laboratories is of concern in some cases.

**3-14. X-rays.** X-rays may be generated from high-voltage (over 15 kilovolts (kV)) power supply tubes. Adequate shielding shall be employed.

## Section IV. SIMPLIFIED RANGE CONTROL MEASURES FOR TYPICAL OPERATIONS OF LASER RANGEFINDERS AND DESIGNATORS

**3-15. Limitations.** The guidance provided in this section deals with range operations in which the laser rangefinder or designator is aircraft- or vehicle-mounted, tripod-mounted or hand-held, and has a hazardous range of at least 1 kilometer (km). These guidelines should not be applied to laser systems other than those having a beam divergence of 1 degree (17 milliradians) or less.

**3-16. Background.** *a.* The laser system, except for its inability to penetrate targets, can be treated to some extent like a direct-fire, line-of-sight weapon, such as a rifle or machine gun. Thus, the hazard control precautions (AR 385-63) taken with respect to those types of weapons will be more than sufficient to provide most aspects of the safe environment required for laser use. Special control measures for laser use are discussed below.

*b.* The hazard from these types of laser devices is generally limited to exposure of the unprotected eyes of individuals within the direct laser beam or a laser beam reflected from specular (mirror-like) surfaces.

Serious eye damage with permanent impairment of vision can result to unprotected personnel exposed to the laser beam. The hazard of exposure to the skin is small compared to exposure to the eye; however, personnel should avoid direct exposure to the unprotected skin within a Distance  $t$  (see table 3-1) of the laser. At normal operating distances these lasers will not burn the skin or cause physical discomfort, but can result in eye injury.

*c.* Essentially, the laser beam travels in a straight line so it is necessary to provide a backstop, such as a hill behind the target during laser firing (see fig 3-8). Calculated NOHDs often extend even beyond 10 km, and the use of optical viewing instruments within the beam could extend the NOHD considerably. For this reason, and because of atmospheric effects upon the beam, the designation of a single "safe" range for firing range safety purposes is not feasible for most testing and training purposes. An official NOHD is established by the USAEHA for specialized use by installation range control officers.

Table 3-1. Buffer Zone Values for Currently Fielded Equipment.

Device/mounting	Distance		NOHD	NOHD*	Horizontal and vertical buffer zones	
	t	s			Static	Moving
	(m)	(m)				
AN/VVS-1 (M60-A2)	10	100	10,000	80,000	5 mils	10 mils
AN/VVG-1 (M551-A1)	10	60	10,000	80,000	2 mils	Not permitted
AN/VVG-2 (M60-A3)	10	60	10,000	80,000	2 mils	5 mils
ESSLR 29 dB	0	from target	300	3,100	2 mils	5 mils
ESSLR 55 dB	0	0	0	0	NA	NA
AN/TVQ-2 (Tripod) Designator	0	60	25,000	80,000	2 mils	Devices not used on the move in training
With 10 dB Attenuator	0	60	12,000	52,000	2 mils	
AN/TVQ-2 Rangefinder	0	60	8,000	40,000	2 mils	
With 10 dB Attenuator	0	60	2,400	22,000	2 mils	
AN/PAQ-3 (Tripod) Designator	0	60	20,000	79,000	2 mils	
AN/PAQ-3 Rangefinder	0	60	6,500	35,000	2 mils	5 mils
AN/PAQ-1 (Hand-Held)	0	160	7,700	33,000	10 mils	
LAAT (AH-1S) (Modernized)	0	60	5,000	30,000	5 mils	5 mils
AN/VVG-3 (Abrams Tank)	0	60	7,000	35,000	2 mils	5 mils
AN/GVS-5 (Hand-Held)	0	200	2,700	13,000	10 mils	Device not used on the move in training
With 19 dB Attenuator	0	2	290	1,800	10 mils	
With 29 dB Attenuator	0	only from target	56	550	10 mils	
TADS (Apache)	0	200	20,000+	70,000+	5 mils	5 mils

Legend: NOHD\* -- Nominal Ocular Hazard Distance with magnifying optics; + -- Pending evaluation of production model.

Note: Devices listed in this table can seriously injure the unprotected eye of individuals within the laser beam. Intrabeam viewing of either the direct beam or the beam reflected from flat specular surface exposes personnel to a potential eye hazard. All distances are in meters.

d. Every object that the laser beam strikes will reflect some energy back toward the laser. In most cases, this energy is a diffuse reflection and is not hazardous if the target is located beyond Distance t; however, certain flat shiny reflecting surfaces should be avoided as targets to prevent a hazardous amount of radiation from being reflected. These conditions are described in paragraphs 3-17 through 3-27.

3-17. Laser Instruction. a. Personnel involved in operation of potentially hazardous laser equipment

should receive instructions that will give them an understanding of the hazards for that particular laser, allay unfounded fears, and prescribe if needed, proper protective equipment.

b. In addition to instruction in the laser device or simulator, indoctrination material required for classroom instructors and range personnel should cover—

- (1) Principles of reflection/refraction of light.
- (2) Hazards of the laser beam on man.

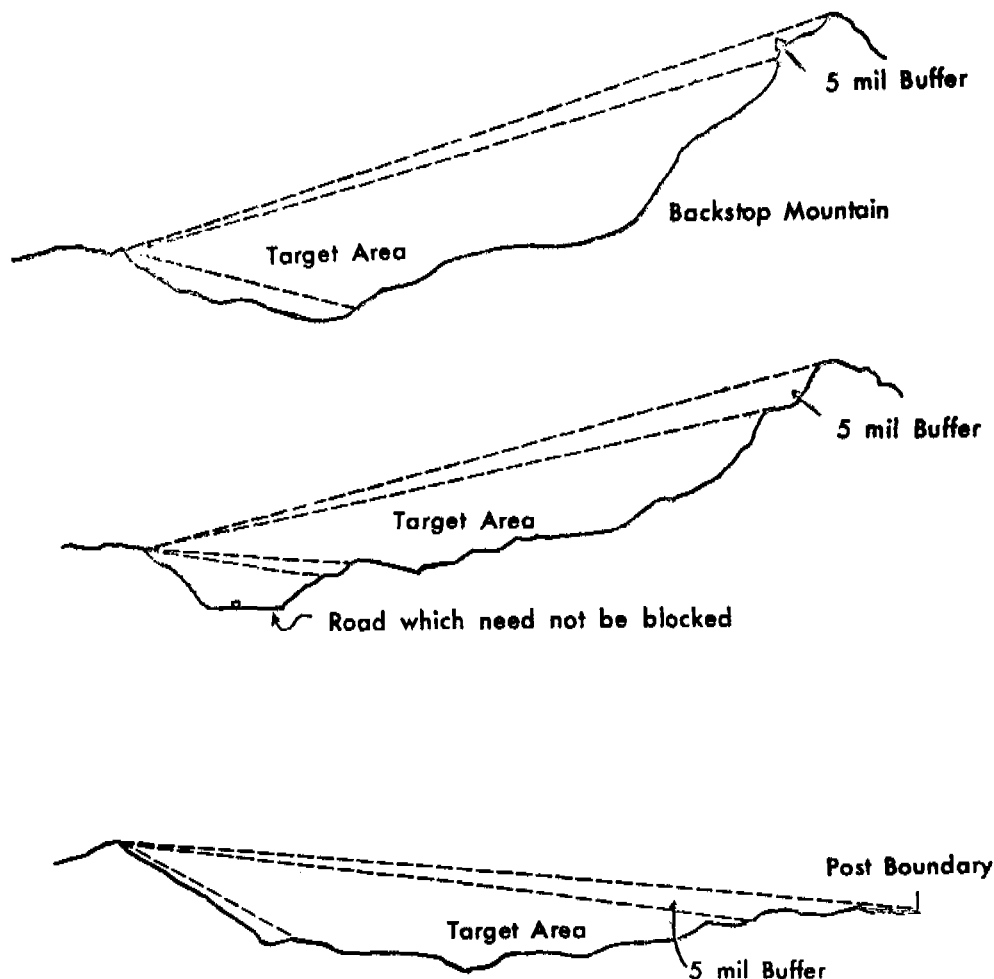

Figure 3-8. Laser range terrain profiles with backstops.

(3) Safety standards for operational control procedures.

(4) Protective equipment.

(5) Preparation of range areas for laser use (e.g., cover, remove, or avoid flat specular surfaces).

(6) Laser indoctrination should be provided to students during relevant advanced individual training (AIT), and to officers during basic courses, simultaneously with the basic weapon systems instruction. The classroom instructors should be knowledgeable in operator and crew aspects of laser safety. Reference publications on subject lasers should be readily available. The instruction presented should be at the user level (complex scientific data or terminology should be avoided). Training films, if available, should be included in the instruction program. Hazard data on lasers incorporated into TMs and FMs on the related weapon system or on the laser subsystem should be stressed. Information as to the appropriate channels for obtaining professional safety and medical assistance should be addressed during the indoctrination period.

**3-18. Range Control Procedures.** The underlying concept of range safety is to prevent intrabeam viewing by unprotected personnel. This is accomplished by locating target areas where no lines-of-sight exist between lasers and uncontrolled, potentially occupied areas, and by removing flat specular surfaces from targets. Recommended target areas are those without specular (mirror-like) surfaces. A flat specular surface is one in which you can see a relatively undistorted image. Examples of specular surfaces are vehicle windows, vision blocks, searchlight cover glass, plastic sheets, or mirrors. Glossy foliage, raindrops, and other natural objects are not hazardous targets. If target areas have no flat specular surfaces, range control measures can be limited to the control of the direct beam path between the laser and the backstop.

**3-19. Range Boundaries.** *a. Nominal ocular hazard distance.* The NOHD for direct intrabeam viewing is the distance beyond which an unprotected individual may stand in the beam and be exposed repeatedly

without injury, provided he or she does not look at the laser with unfiltered magnifying optical devices. When viewing the collimated beam with a telescope the hazardous range is greatly increased. For instance, a 10 km NOHD could be increased to 80 km for an individual looking back at the laser from within the beam with 13-power optics. In almost all cases, it is not possible to control such large amounts of real estate. The solution to this problem is to use a backstop to insure that lines-of-sight do not exist between the laser device and potential observers behind the target.

*b. Backstops.* Backstops are opaque structures or terrain in the controlled area that completely terminate the laser beam if it misses the target. Examples include a dense tree line, a windowless building, or a hill that completely obstructs any view beyond it and does not have a flat, mirror-like surface. The hazard distance of the laser device is the distance to the backstop; this hazard distance shall be controlled. The terrain profile from the laser device's field of view plays a very important role since the laser presents only a line-of-sight hazard. *The optimal use of natural backstops is the obvious key to minimizing laser range control problems.*

*c. Buffer zones.* The extent of horizontal and vertical buffer zones around the target area, as viewed from the firing area, depends upon the aiming accuracy and stability of the laser device. A vertical buffer zone covers the angular distance below the highest point on a backstop to the target and the angular distance above the lowest point on a backstop to the target area. Vertical buffer zones are only necessary when lines-of-sight exist to uncontrolled high ground beyond the target or when downrange air space is not controlled to the NOHD. The horizontal buffer zone covers the angular distance to the left of the leftmost target and the right of the rightmost target. The laser horizontal buffer zones could partially or completely be included in lateral safety or ricochet areas on ranges where the laser is used with live-fire weapons (fig 3-9). Table 3-1 lists buffer zone values for currently fielded equipment.

*d. Laser surface danger zone (LSDZ).* The lateral boundaries of the LSDZ include the horizontal buffer zones described above. The downrange dimensions (e.g., Distance  $t$  and NOHD) of the areas described below differ according to the type of device being used. Distance  $s$  is the radius of a circle around the target in which flat specular surfaces shall be removed. Table 3-1 lists these downrange dimensions for current laser devices. Depending on the device(s) being used, the dimensions in table 3-1 should be applied to the laser safety danger zone (LSDZ) in figure 3-9.

(1) *LSDZ Area T.* This area extends from the laser firing point to  $t$  meters downrange. No objects

will be lased within LSDZ Area T. Although the hazard of exposure to the skin is insignificant compared to exposure to the eye, personnel should avoid direct exposure to the unprotected skin up to  $t$  meters from the laser device.

(2) *LSDZ Area S.* This area extends around the target and is a circle of radius  $s$ . Specular surfaces visible from the firing line with field binoculars should be removed, but the object may be covered or painted with lusterless paint if it cannot be removed. Flat, mirror-like objects in the sense of this provision are mirrors, chrome-plated metal, and panes of glass or plastic.

(3) *LSDZ Area Z.* On the ground, this area normally extends to an adequate backstop or the NOHD for magnified viewing (fig 3-9B). Lasing at targets on the horizon (no vertical buffer zone) is permitted as long as air space is controlled to the NOHD for nonmagnified viewing. In this case LSDZ Area Z extends downrange to the NOHD in the air space, but only to the skyline on the ground as seen from the lasing position (fig 3-9C). Operators and crews shall only lase at approved aerial targets. In the unusual case where there are no natural backstops available (e.g., desert flats), the extended NOHD may extend out to extremely long ranges (e.g., 80 km for tank-mounted laser rangefinder (LRF)). This extreme situation could only occur if there were a direct line-of-sight to an observer on the ground and there were a possibility that the observer could be engaged in direct intrabeam viewing with unfiltered magnifying optics (fig 3-9A).

**3-20. Optical Instruments.** *a. Unfiltered daylight optics.* The use of unfiltered daylight optical devices to observe the target during laser operation is permitted if flat specular surfaces have been removed from the target area. Specular targets can be observed only if appropriate laser safety filters are placed in the optical train of the magnifying optics.

*b. Passive night vision devices.* Image intensifiers and thermal night sights provide a degree of laser eye protection because you do not view the scene directly. Devices such as the AN/PVS-5 have not been designated as laser protective eyewear and a small probability exists that laser energy may enter the eye through open spaces around the tube mounts in the goggles.

**3-21. Warning Signs.** Evaluation of each anticipated operating condition should include consideration and development of procedures for insuring proper placing of warning signs for that operation. Local SOPs should provide for the placement of temporary or permanent signs during such periods of operation. A sign such as shown in figure 3-5 should be used. The symbol is red with black lettering on white back-

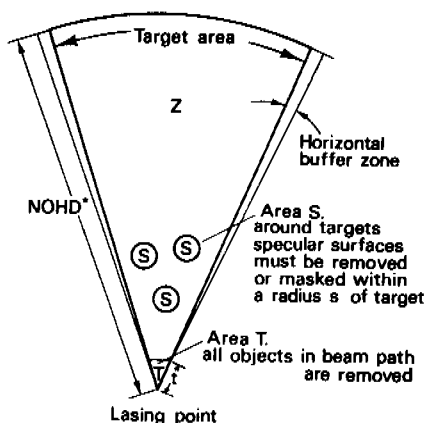

A. IF THERE IS NO BACKSTOP AND LINES-OF-SIGHT EXIST TO OCCUPIED GROUND POSITIONS.

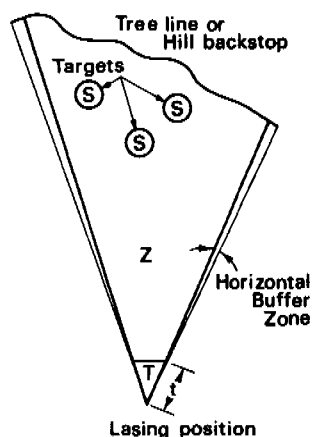

B. IF BEAM TERMINATED AND ADEQUATE VERTICAL BUFFER ZONE EXISTS. THE DANGER AREA EXTENDS TO THE BACKSTOP. THE FURTHEST DOWNRANGE DISTANCE MAY BE FAR LESS THAN THE NOHD

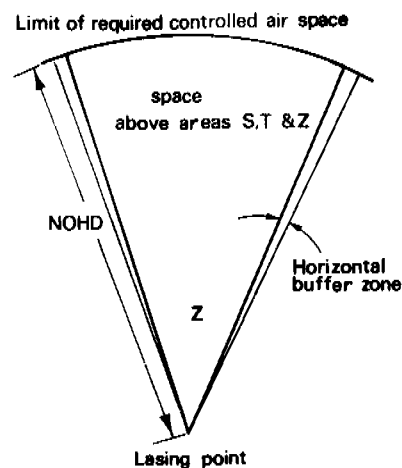

C. INADEQUATE VERTICAL BUFFER ZONE OR 'SKY SHOOTING'. THIS DANGER FAN DESCRIBES THE LIMIT OF CONTROLLED AIRSPACE THE GROUND CONTROL FAN MAY BE SIMILAR TO A OR B

Figure 3-9. Laser safety danger zones.

ground. Signs should also be according to AR 385-30.

3-22. **Approved Targets.** The laser operator shall—

a. Only fire at designated targets that are diffuse reflectors.

b. Never fire at specular surfaces such as glass, mirrors, windows, flat chrome-plated surfaces, etc. This constraint can be met by removing, covering, or painting specular surfaces on vehicles with lusterless paint.

3-23. **Eye Protection.** Those within the LSDZ for each device, such as moving target operators, shall wear laser protective eyewear with *curved* protective lenses during laser firing (see para F-2f). Such eyewear must be approved for the wavelength of the laser device being fired (such as AN/VVG-1, etc.). A laser filter designed for protection against one wavelength of laser may not protect against harm from another. See table 3-2 for the wavelength and optical density required for the currently fielded devices. If more than one type of device is used, protective mea-

Table 3-2. Protective eyewear data

Device	Optical density	Wavelength (nm)	Type	Reference TM
AN/VVS-1	5.8	694.3	Ruby	9-2350-230-10
AN/VVG-1	5.8	694.3	Ruby	9-2350-232-10
AN/VVG-2	5.8	694.3	Ruby	9-2350-253-10
AN/GVS-5	4.4	1064	NdYAG	11-5860-201-10
G/VLLD (AN/TVQ-2)	5.5	1064	NdYAG	9-1260-477-12
MULE (AN/PAQ-3)	5.6	1064	NdYAG	—
AN/PAQ-1	5.8	1064	NdYAG	9-1260-479-12
LAAT	4.8	1064	NdYAG	55-1520-236-10
TADS	5.5	1064	NdYAG	—
AN/VVG-3	4.7	1064	NdYAG	9-2350-255-20-1-1

## NOTE

If more than one type device is used, protective measures shall cover all devices. For devices of the same wavelength, the highest required optical density shall be used.

ures shall cover all devices. For devices of the same wavelength, the highest required optical density shall be used.

**3-24. Countdown.** A countdown is not required prior to firing in a range environment. The use of range flags during firing serves the purpose of notifying personnel that laser firing or live firing is in progress. Radio communication with personnel down-range in the target area shall be provided during laser operation to insure that proper eye protection is being worn by such personnel.

**3-25. Weather and Environmental Conditions.** *a. Inclement weather and night operation.* No additional precautions are required at night or during rain, snow, or fog.

*b. Standing snow, ice, and water.* Specular reflections from standing snow, ice, or water do not present a significant additional hazardous situation to ground personnel and also do not present a hazard to personnel in aircraft outside of the NOHD air space.

**3-26. Operation Outside of Range Area.** *a.* The laser exit port shall be covered by an opaque dust cover or ballistic cover when the laser is not in use to prevent accidental firing of the device. This requirement includes tactical training exercises, road marches, when the vehicle is parked, or when the device is in storage. This requirement does not include "dry firing" exercises where the laser beam and optical sight are coaxial as is the case with the M1 and the M60A3 LRF.

*b.* The laser system shall not be operated or experimented with outside of its operational role or when removed from its mount unless specifically authorized by the appropriate maintenance manual.

**3-27. Laser Operations From Aircraft.** These guidelines apply to operation of airborne LRFs and designators aimed at ground targets. These operations

can cause ocular injury to ground personnel observing the laser source directly, or indirectly by specular reflection, at most operational altitudes.

*a.* It is generally desirable to clear the target area of flat specular surfaces. The pilot of the aircraft assigned to fly over the firing area shall be instructed to visually check for possible specular items before laser operation by noting the location of standing water and the position of vehicles and buildings that may contain glass.

*b.* Laser protective eyewear with curved filter lenses shall be made available for personnel required to be in the vicinity of the target area during laser operation. The eye protectors shall provide an optical density appropriate for the operation at the laser wavelength. For devices having an output energy per pulse less than 0.1 Joule, an optical density of 6 is adequate. Reduced optical densities may be possible in specific instances.

*c.* The use of eye protection that reduces the vision of aircrew personnel shall be discouraged; other hazard controls should be utilized instead. Normally, only if the aircraft is being directly illuminated by a laser beam (e.g., by a ground-to-air LRF), should eye protection for the aircrew be considered.

*d.* The installation surgeon shall be notified prior to initial laser operations so that if any personnel are required to receive a thorough ophthalmological examination prior to working with the laser per chapter 2, section II, they can receive such examinations.

*e.* The flightcrew shall take all precautions to insure that the laser is fired only at designated targets.

*f.* All ground personnel shall be instructed to assume that the laser is in operation at all times whenever the aircraft is firing on targets or is above an active range.

*g.* The officer-in-charge or operator shall insure that the laser system is secured and unable to fire when the aircraft is in some location other than an authorized firing site.

*h.* The installation range control officer and local air traffic controllers shall assure that adequate danger zones are established and that strict control of traffic is maintained as necessary. Normally a range control office(r) will—

(1) Coordinate the mission with other activities within the laser operational area and furnish all required information to control tower operators and authorized ground control stations associated with the mission.

(2) Thoroughly brief all pilots prior to their engaging in any mission within the danger area in which lasing will take place. The briefing should include the geography of the area, access and exit routes, limits of flight pattern, radio frequencies to be employed, and applicable local procedures. Whenever practicable, each pilot assigned to a training mission shall make a dry run prior to the mission to become acquainted with the prescribed course and the test area.

*i.* Laser operations shall not be initiated unless appropriate buffer zones (table 3-1) exist on all sides of the target within the government controlled property area.

**3-28. Laser Safety Output Attenuators.** Optical glass filters have been developed to greatly reduce

the output energy of some fielded lasers (e.g., the M60A3 tank LRF, the AN/GVS-5 LRF, and the AN/TVQ-2). These filters reduce the NOHD or completely eliminate a hazardous laser output for training purposes. Use of some filters make it possible for lasers to be used during two-sided tactical exercises. Revised safety procedures applicable to filter use are given in the appropriate TMs (see table 3-2).

**3-29. Hangar, Garage, and Maintenance Shop Procedures.** *a.* All testing performed in shop areas will be strictly controlled with barriers and signs.

*b.* Firing of the laser in shop areas should be into a light-tight box expressly designed to contain all of the laser output, where feasible.

*c.* The maintenance officer shall insure that the number of operating personnel on the site for testing does not exceed that necessary to accomplish the task safely and efficiently. Transient personnel are restricted to those having an official interest in the test and shall be cleared by the maintenance officer.

*d.* Check tests requiring operation of a laser over an extended distance (i.e., 100 m to 1000 m)—

(1) Should be conducted in occupied areas only under strict controls.

(2) Insure that the beam can only travel along a tightly controlled path defined by a beam aperture located at 1 m and 10 m from the laser (fig 3-10).

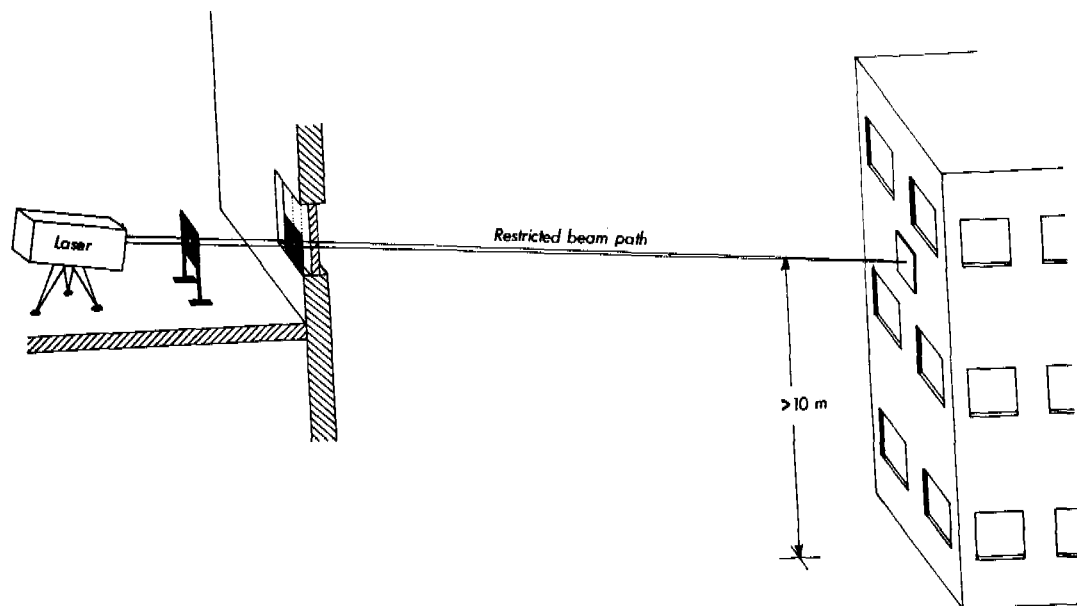

The test range is established by limiting beam elevation and azimuth to insure that the beam strikes a diffuse backstop; the beam path is above occupied areas.

Figure 3-10. Maintenance test range.

## CHAPTER 4

### PERSONAL PROTECTIVE EQUIPMENT

---

**4-1. Eye Protection.** *a.* Personnel whose occupation or assignment require exposure to laser beams should be furnished suitable laser safety goggles. The goggles shall protect for the specific wavelength(s) of the laser and have an optical density adequate for the energy involved.

*b.* Table 4-1 lists the maximum power, energy, irradiance, or radiant exposure for which adequate protection is afforded by filters of optical densities from 1 through 7.

*c.* Eye protection should have curved lenses to reduce specular reflection hazards.

**4-2. Skin Protection.** Needless exposure of the skin of personnel should be avoided for Classes 3 and 4

lasers. When the hands or other parts of the body must be exposed to potentially hazardous levels, protective coverings, gloves, or shields shall be used. The face should be turned away from the target area. Laser welding and cutting facilities should have sufficient shielding surrounding the article being welded to prevent viewing the operation by persons other than the welder.

**4-3. Low Temperature Protection.** Impervious, quick removal gloves, face shields, and safety glasses should be provided as protection for personnel who handle the extremely low temperature coolants that may be used in some high-powered lasers.



Table 4-1. Simplified Method for Selecting Laser Eye Protection for Intrabeam Viewing for Wavelengths Between 400 and 1400 nm.

Q-switched lasers (1 ns to 0.1 ms)		Non-Q-switched lasers (0.4 ms to 10 ms)		Continuous lasers momentary (0.25 to 10 s)		Continuous lasers (Long term staring greater than 3 hrs)		Attenuation	
Maximum output energy (J)	Maximum beam radiant exposure (J·cm <sup>-2</sup> )	Maximum laser output energy (J)	Maximum beam radiant exposure (J·cm <sup>-2</sup> )	Maximum power output (W)	Maximum beam irradiance (W·cm <sup>-2</sup> )	Maximum power output (W)	Maximum beam irradiance (W·cm <sup>-2</sup> )	Attenuation factor	OD
1.0	2	10	20	NR	NR	NR	NR	10,000,000	7
10 <sup>-1</sup>	2 x 10 <sup>-1</sup>	1.0	2	NR	NR	1.0	2	1,000,000	6
10 <sup>-2</sup>	2 x 10 <sup>-2</sup>	10 <sup>-1</sup>	2 x 10 <sup>-1</sup>	NR	NR	10 <sup>-1</sup>	2 x 10 <sup>-1</sup>	100,000	5
10 <sup>-3</sup>	2 x 10 <sup>-3</sup>	10 <sup>-2</sup>	2 x 10 <sup>-2</sup>	10	20	10 <sup>-2</sup>	2 x 10 <sup>-2</sup>	10,000	4
10 <sup>-4</sup>	2 x 10 <sup>-4</sup>	10 <sup>-3</sup>	2 x 10 <sup>-3</sup>	1.0	2	10 <sup>-3</sup>	2 x 10 <sup>-3</sup>	1,000	3
10 <sup>-5</sup>	2 x 10 <sup>-5</sup>	10 <sup>-4</sup>	2 x 10 <sup>-4</sup>	10 <sup>-1</sup>	2 x 10 <sup>-1</sup>	10 <sup>-4</sup>	2 x 10 <sup>-4</sup>	100	2
10 <sup>-6</sup>	2 x 10 <sup>-6</sup>	10 <sup>-5</sup>	2 x 10 <sup>-5</sup>	10 <sup>-2</sup>	2 x 10 <sup>-2</sup>	10 <sup>-5</sup>	2 x 10 <sup>-5</sup>	10	1

Note: By using this table, higher than necessary optical densities may be arrived at. See appendix F for further details on laser eye protection and optical density.  
 NR-- Not recommended as a control procedure at these levels. These levels of output power may damage or destroy the attenuating material used in the eye protection. Skin protection would also be required at these levels.

## CHAPTER 5 ADMINISTRATION

---

**5-1. Accident Reporting.** Procedures now in effect for reporting suspected overexposures from nonionizing radiation are given in AR 40-400 and AR 385-40. AR 40-400 requires that when an individual is treated on an inpatient or outpatient basis for a suspected overexposure to nonionizing radiation that a MED 16 form be submitted to HQDA (DASG-PSP). Per AR 385-40, nonionizing radiation accidents shall be reported within 72 hours to HQDA (DASG-PSP), HQDA (DAPE-HRS), and AMC (AMCSF-P/AMCSG-R). Any necessary investigation shall be directed by HQDA (DASG-PSP).

**5-2. Biological Data.** The Division of Ocular Hazards, LAIR, conducts research and development to

obtain data on the biomedical effects of laser radiation. Biological research data required for the safety evaluation of new types of lasers is available to development agencies upon written request to: Chief, Division of Ocular Hazards, Letterman Army Institute of Research, Presidio of San Francisco, CA 94129-6700.

**5-3. Technical Assistance.** The services of USAEHA are available upon written request to Commander, US Army Environmental Hygiene Agency, ATTN: HSHB-RL, Aberdeen Proving Ground, MD 21010-5422, with a copy furnished to Commander, US Army Health Services Command, ATTN: HSCL-P, Fort Sam Houston, TX 78234-6000.

## APPENDIX A REFERENCES

---

### Section I. REQUIRED PUBLICATIONS

AR 10-5	Department of the Army.
AR 40-5	Preventive Medicine.
AR 40-46	Control of Health Hazards from Lasers and Other High Intensity Optical Sources.
AR 40-400	Patient Administration.
AR 385-30	Safety Color Code Markings and Signs.
AR 385-9	Safety Requirements for Military Lasers.
AR 385-40	Accident Reporting and Records.
AR 385-63	Policies and Procedures for Firing Ammunition for Training, Target Practices, and Combat.
TB MED 506	Occupational Vision.

### Section II. RELATED PUBLICATIONS\*

FM 21-11 (Test)	First Aid for Soldiers
TM 9-1260-477-12	Operator's and Organizational Maintenance Manual for Electro-Optical Target Designator Set, AN/TVQ-2 (G/VLLD) (NSN 1260-01-046-2843) and (G/VLLD M113A1 Vehicle Adapter (NSN 2590-01-046-2832)
TM 9-1260-479-12	Operator's and Organizational Maintenance Manual for Laser Target Designator, AN/PAQ-1 (LTD)
TM 9-2350-230-10	Operator's Manual (Crew) for Armored Reconnaissance/Airborne Assault Vehicle, Full-Tracked, 152-MM Gun/Launcher M551 (NSN 2350-00-873-5408) and M551A1 (NSN 2350-00-140-5151)
TM 9-2350-232-10	Operator's Manual: Tank, Combat, Full-Tracked: 152-MM Gun/Launcher, M60A2 W/E (NSN 2350-00-930-3590)
TM 9-2350-253-10	Operator's Manual for Tank, Combat, Full-Tracked, 105-MM Gun, M60A3 (NSN 2350-00-148-6548) and TTS (Tank Thermal Sight) (NSN 2350-01-061-2306)
TM 9-2350-255-20-1-1	Organizational Maintenance Manual Scheduled Maintenance for Tank, Combat, Full-Tracked: 105-MM Gun, M1 (NSN 2350-01-061-2445), GENERAL ABRAMS, Hull
TM 11-5860-201-10	Operator's Manual: Laser Infrared Observation Set, AN/GVS-5 (NSN 5860-01-062-3543)
TM 55-1520-236-10	Operator's Manual, Army Model AH-1S (PROD), AH-1S (ECAS), and AH-1S (Modernized Cobra) Helicopters
	<i>A Guide for Control of Laser Hazards.</i> American Conference of Governmental Industrial Hygienists, Cincinnati, Ohio (1981).
	<i>Laser Safety Guide.</i> Laser Institute of America, Cincinnati, Ohio (1976).

---

\*A related publication is merely a source of additional information. The user does not have to read it to understand this bulletin.

## APPENDIX B INTRODUCTION TO LASERS

**B-1. General Information.** *a.* Lasers are finding ever increasing military applications—principally for target acquisition, fire control, and training. These lasers are termed rangefinders, target designators, and direct-fire simulators. Lasers are also being used in communications, precision distance measurements, guidance systems, metal working, photography, holography, and medicine.

*b.* Laser radiation should not be confused with ionizing radiation (X-rays and gamma rays) even though laser beams with high irradiances have been known to produce ionization.

*c.* The word *laser* will be applied to devices using light amplification by stimulated emission of radiation and usually operating with an output wavelength of approximately 180 nm (0.18  $\mu\text{m}$ ) to 1000  $\mu\text{m}$  (1 mm). Most lasers operate in one of the following modes—

- (1) Continuous wave (CW).
- (2) Normal pulse.
- (3) Q-switched pulse.
- (4) Mode-locked pulse.
- (5) Repetitively pulsed.

**B-2. The Nature of Light.** The word *light* as properly used, refers to that portion of the electromagnetic spectrum that produces a visual effect. It was first shown by James Clerk-Maxwell in 1873 that light is electromagnetic radiation which propagates at approximately  $3 \times 10^8$  meters per second. Albert Einstein later predicted that the velocity of light in a vacuum was constant throughout the universe and was the ultimate speed at which energy may be transmitted. Quantum mechanics describe the smallest indivisible quantity of radiant energy as one photon. The amount of energy ( $Q_q$ ), represented by one photon, is determined by the frequency  $\nu$ , and Planck's constant,  $h$ .

$$Q_q = h\nu$$

The frequency,  $\nu$ , and wavelength,  $\gamma$ , of light are related by the velocity of light,  $c$ , so that knowing one, the other may be determined by use of the relationship.

$$c = \nu\lambda$$

Humans have made use of almost the entire electromagnetic spectrum from zero Hertz (Hz) (such as direct current from storage batteries) to  $10^{24}$  Hz (the very hard X-rays used for nondestructive inspection of metal parts). Figure B-1 shows the electromagnetic spectrum and some of its uses and properties.

**B-3. Production of Light.** *a.* Electromagnetic radiation is emitted whenever a charged particle (e.g., an electron) gives up energy into an electric field. This

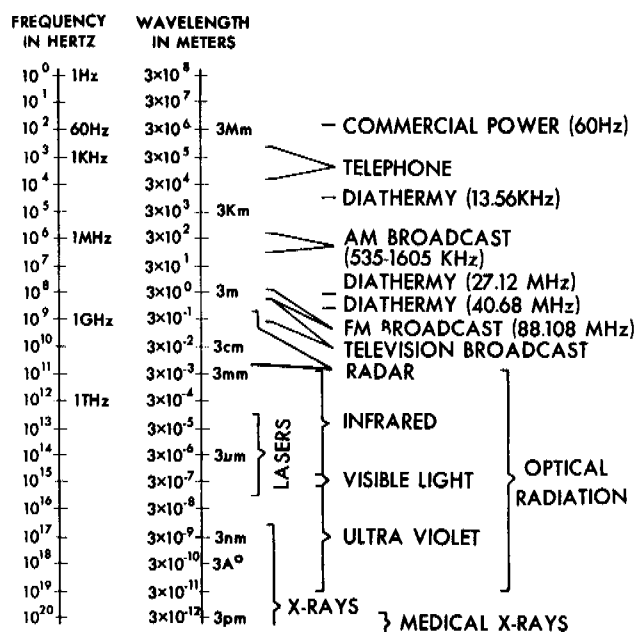

Figure B-1. The electromagnetic spectrum.

happens every time an electron drops from a higher energy state to a lower energy state in an atom or ion (fig B-2).

*b.* In ordinary light sources, electron transitions from higher energy states to lower energy states occur randomly and spontaneously, and one photon has no correlation with another. In a laser, however, these transitions are stimulated by photons of precisely the right energy. The stimulated emissions occur with exactly the same wavelength, phase, and direction as the photons that stimulated the emissions.

*c.* Electrons must be raised to higher energy levels before they can make the transitions to lower energy levels and radiate photons. There are many ways in which electrons can be raised to high energy levels or become "excited." By—

- (1) Heating, as in the filament of an incandescent lamp.
- (2) Collisions with other electrons, as in a fluorescent lamp discharge or in a television picture tube.
- (3) Absorbing energy from photons, as in luminescent paint on a watch dial.
- (4) Chemical reactions, as in a flame.

*d.* In addition to the familiar electronic energy levels, a molecule can also have energy levels arising

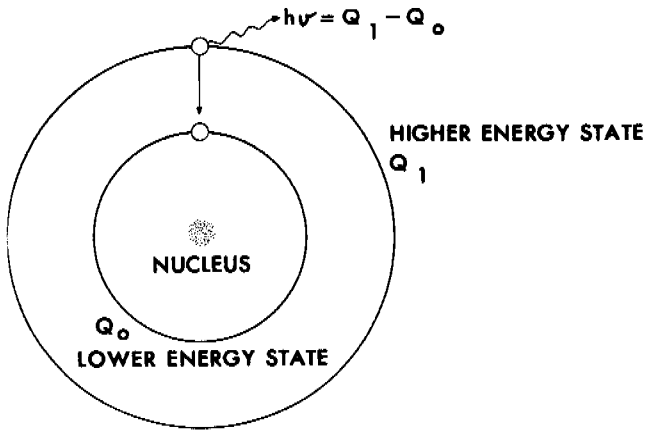

Figure B-2. Emission of radiation by transition of an electron from a higher energy state to a lower energy state.

from the vibrational and rotational motion of the molecules.

**B-4. Components of a Laser.** The laser has three basic components:

- a. A lasing medium.
- b. A pumping system (energy source).
- c. A resonant optical cavity.

Lenses, mirrors, cooling systems, shutters and other accessories may be added to the system to obtain more power, shorter pulses, or special beam shapes; but only the above three basic components are necessary for laser action.

**B-5. Lasing Medium.** A lasing medium, to have suitable energy levels, must have at least one excited state (metastable state) where electrons can be trapped and not immediately and spontaneously dropped to lower states. Electrons may remain in these metastable states from a few microseconds to several milliseconds. When the medium is exposed to the appropriate pumping energy, the excited electrons are trapped in these metastable states long enough for a population inversion to occur (i.e., there are more electrons in the excited state than in the lower state to which these electrons decay when stimulated emission occurs). Figure B-3 shows a simplified three-level energy diagram for a laser material. This is just one of the many possible systems of energy levels. Although laser action is possible with only two energy levels, most such actions involve four or more levels.

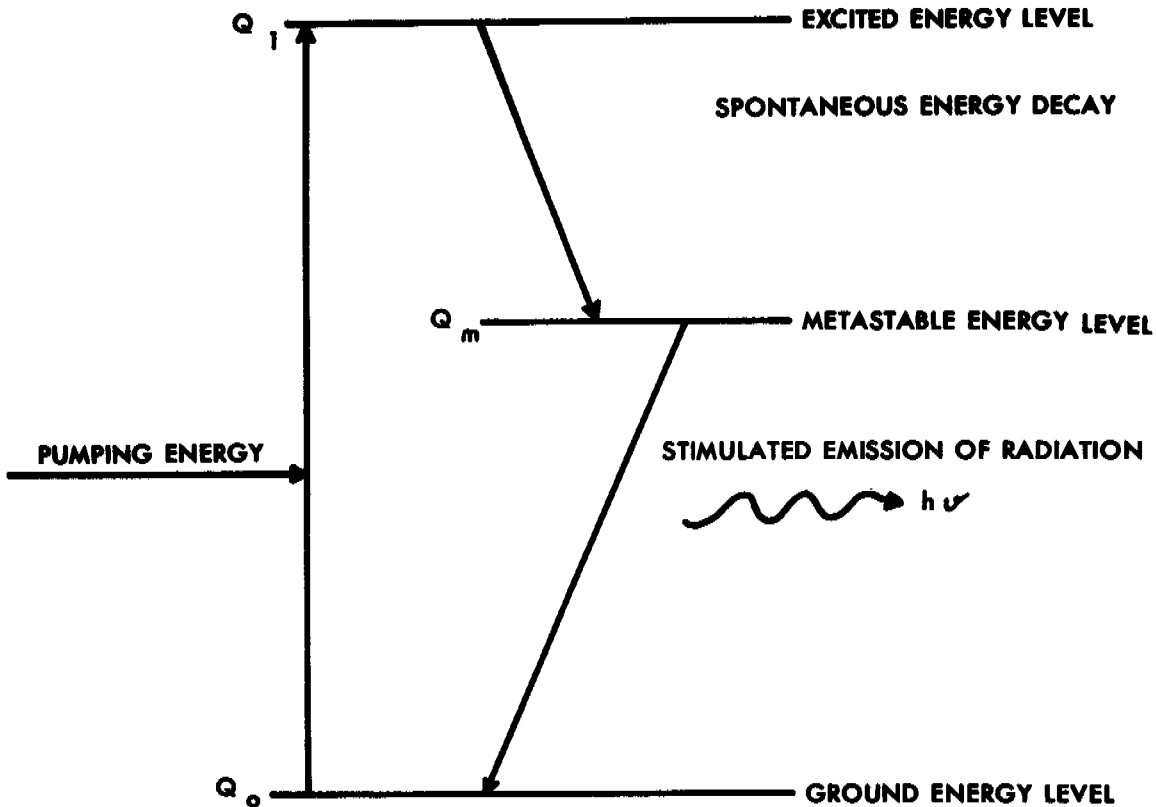

This diagram shows one of the many possible sets of energy levels for laser action.

Figure B-3. Three-level energy diagram.

**B-6. Pumping System.** To raise atoms or molecules to a higher energy level, lasers employ pumping systems (fig B-4). These systems pump energy into the laser material, increasing the number of atoms or molecules in the metastable energy state. When the number of atoms or molecules in the metastable energy state exceeds those in the lower level, a *population inversion* exists and laser action is possible. Several different pumping systems are available. These are—

- a. Optical pumping which uses a strong source of light, such as a xenon flashtube or another laser (e.g., an argon laser).
- b. Electron collision pumping which is accomplished by passing an electric current through the laser material or by accelerating electrons from an electron gun to impact on the laser material (e.g., Helium-Neon lasers).
- c. Chemical pumping which is based on energy released in the making and breaking of chemical bonds (e.g., Hydrogen-Fluoride lasers).

**B-7. Optical Cavity.** A resonant optical cavity is formed by placing a mirror at each end of the laser material so that a beam of light may be reflected from one mirror to the other, passing back and forth through the laser material (fig B-5). Lasers are constructed in this way so that the beam passes through

the material many times and is amplified each time. One of the mirrors is only partially reflecting and permits part of the beam to be transmitted out of the cavity.

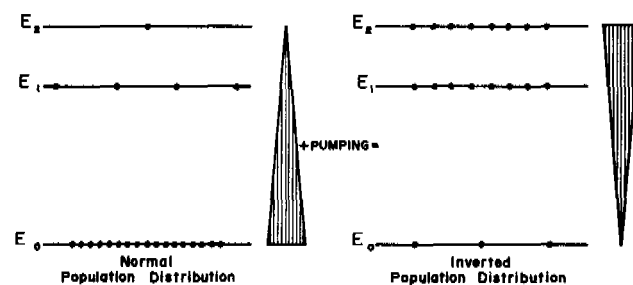

This inversion is produced by pumping electrons from a lower energy state to a higher energy state so that the higher state has more electrons (larger population) than the lower state.

Figure B-4. Population inversion.

**B-8. Laser Operation.** a. Energy is supplied to the laser material by the pumping system. This energy may be stored in the form of electrons trapped in metastable energy levels. Pumping must produce a population inversion before laser action can take place.

b. A population inversion exists for this type of laser when a higher energy level has more electrons

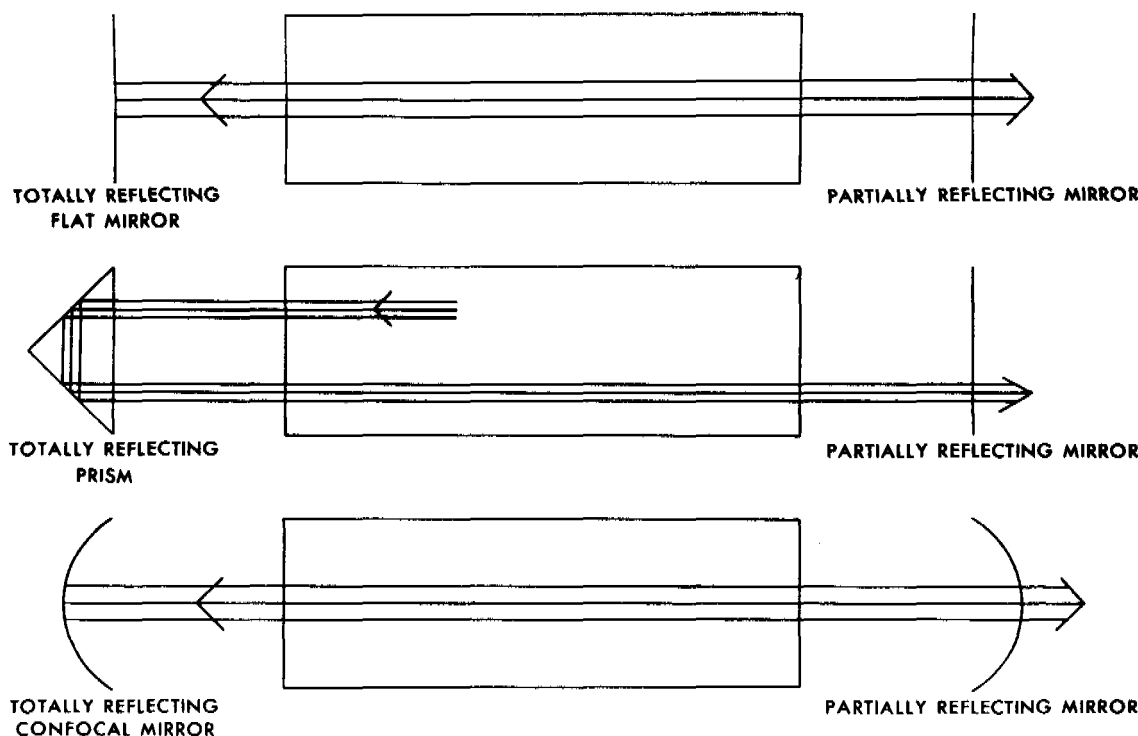

Simple flat mirror system (top).  
 Rotating prism Q-switch system (middle).  
 Confocal mirror system (bottom).

Figure B-5. Three typical optical cavities.

(population) than a lower energy level, which is contrary to natural order. A population inversion is necessary because the stimulated emission would be absorbed by atoms having lower energy level electrons.

c. When a population inversion is achieved, the spontaneous decay of a few electrons from the metastable energy level to a lower energy level starts a chain reaction. The photons emitted spontaneously will stimulate the other electrons to make the transitions from the metastable energy level to lower energy levels, emitting photons of precisely the same wavelength, phase, and direction.

d. When the photons reach the end of the laser material they are reflected by the end-mirror back into the material where the chain reaction continues and the number of photons is increased. When the

photons arrive at a partially reflecting mirror, only a portion will be reflected back into the cavity and the rest will emerge as a laser beam.

**B-9. Types of Lasers.** Lasers are often designated by the type of laser material in the optical cavity.

a. Solid-state lasers employ a glass or crystalline material (fig B-6). Gas lasers employ a pure gas or mixtures of gases (figs B-7 and B-8). Figure B-8 represents the larger type of flowing-gas laser. A still larger type of gas laser (not shown) employs a combustion chamber and supersonic nozzle for population inversion. It is known as a gas dynamic laser. Semiconductor lasers employ transistor materials (fig B-9). Liquid lasers employ an active material in a liquid solution or suspension, usually a dye (fig B-10).

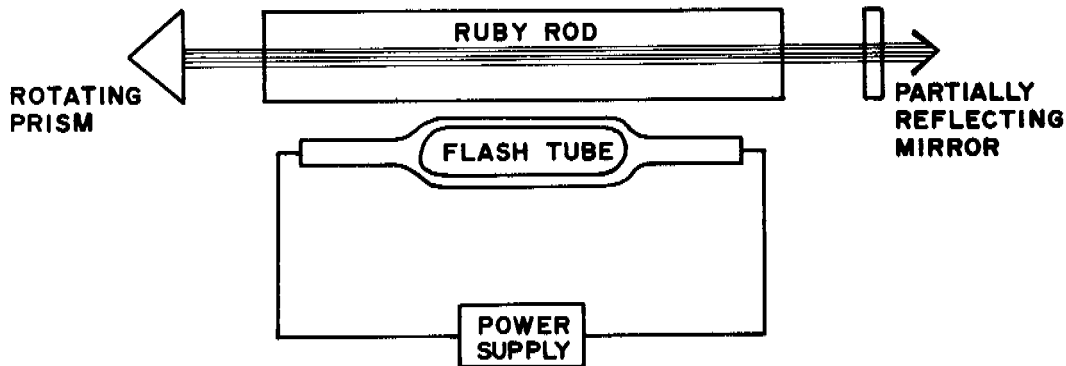

Figure B-6. Schematic of solid-state laser with optical pumping.

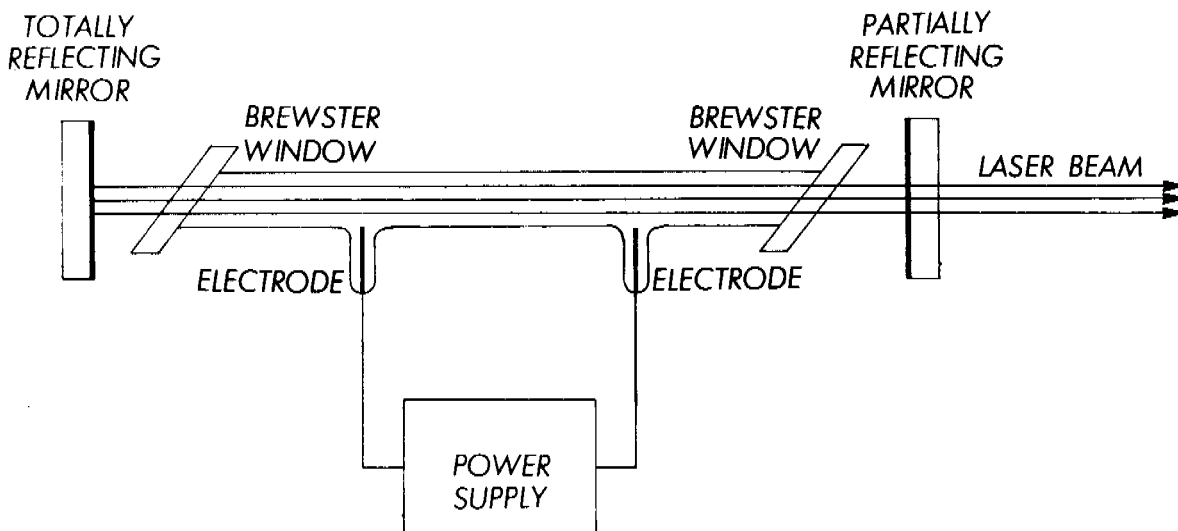
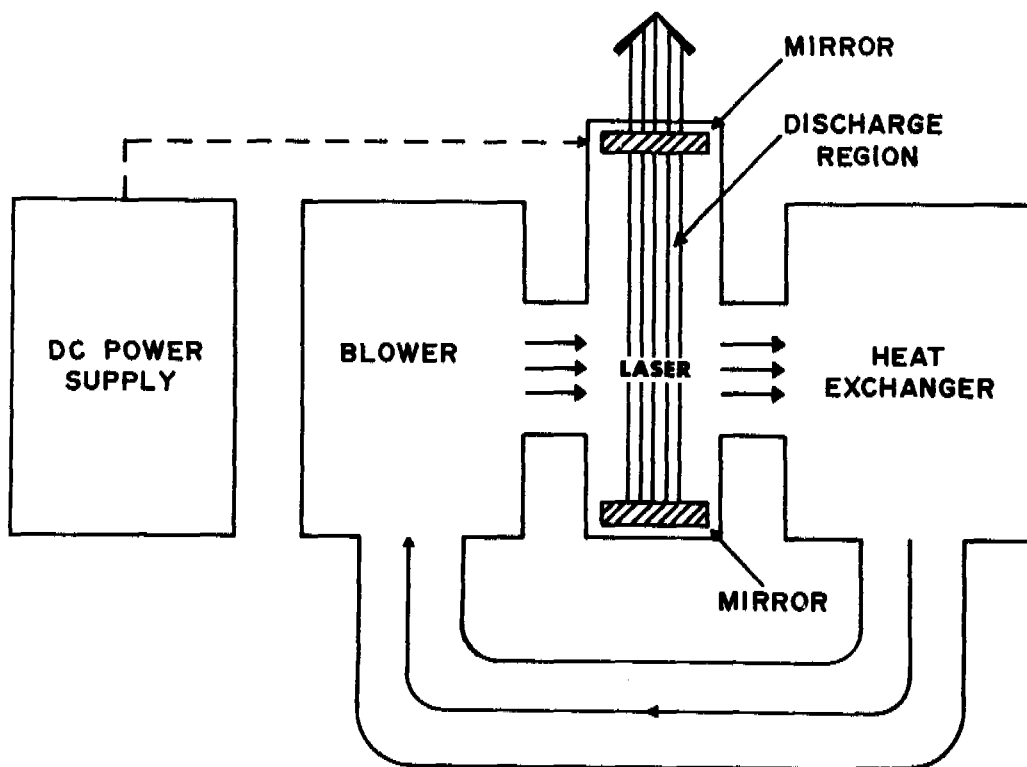

Figure B-7. Schematic of helium-neon laser with electron collision pumping (representative of small gas lasers).



This is representative of a larger type of flowing-gas laser. A still larger type of gas laser (not shown) employs a combustion chamber and supersonic nozzles for population inversion and is known as a gas dynamic laser (GDL).

Figure B-8. Schematic of CO<sub>2</sub> gas transport laser (GTL).

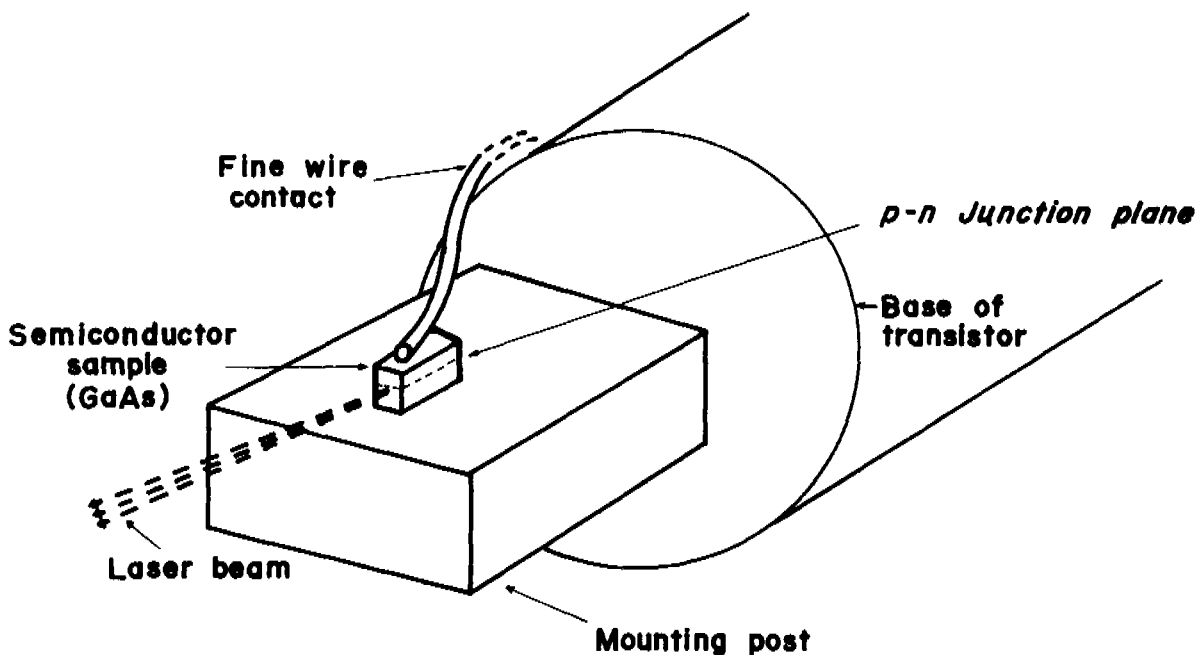

Figure B-9. Schematic of gallium-arsenide laser with direct-current (electron collision) pumping (representative of semiconductor or injection lasers).



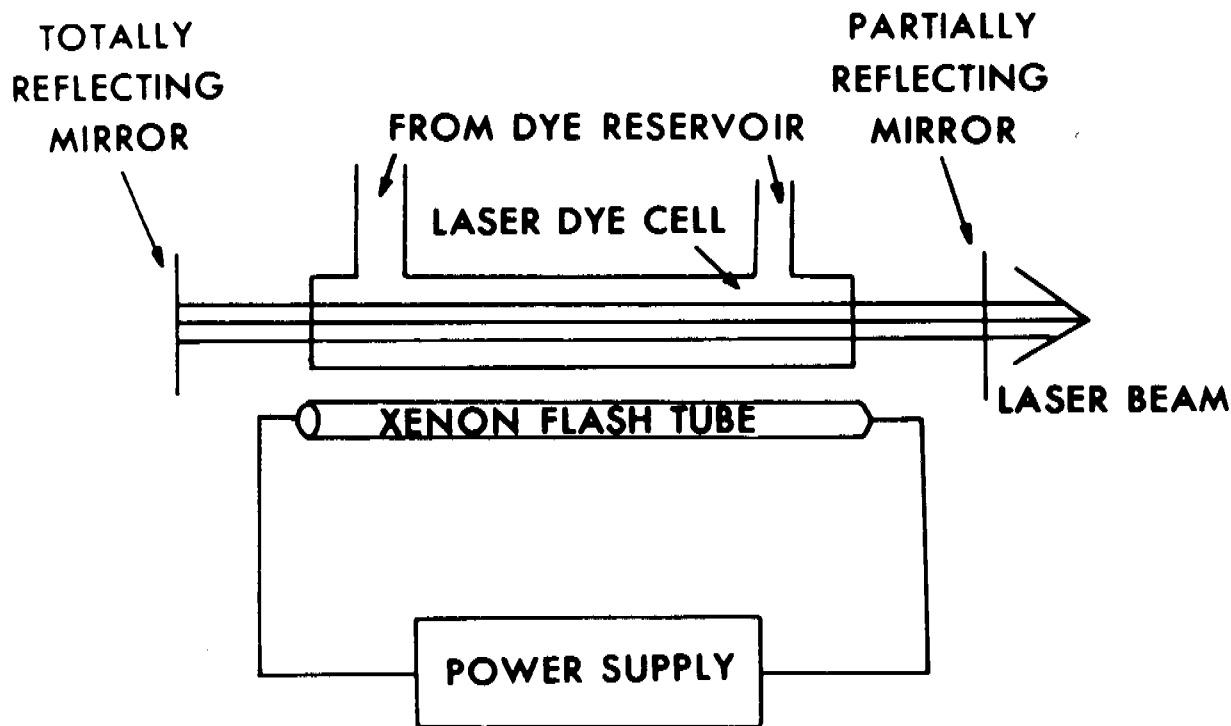

Figure B-10. Schematic of a liquid dye laser with optical pumping.

b. Solid-state and liquid lasers commonly employ optical pumping while gas lasers usually employ electron collision pumping, although some types of liquid and gas lasers have employed chemical-reaction pumping. Semiconductor lasers may be optically pumped by another laser beam or electron-collision pumped by an electron beam or an electric current.

**B-10. Temporal Modes of Operation.** a. The different temporal modes of operation of a laser are distinguished by the rate at which energy is delivered. In general, lasers operating in the *normal-pulse* mode have pulse durations of a few tenths of a microsecond to a few milliseconds. This mode of operation is sometimes referred to as *long-pulse* or just *pulsed*.

b. The quality of the optical cavity of a laser can be changed by placing a shutter between the mirrors. This enables the beam to be turned on and off rapidly and normally creates pulses with a duration of a few tenths of a nanosecond to a few tenths of a microsecond. This mode of operation is normally called *Q-switched*, although it is sometimes referred to as *Q-spoiled* or *giant-pulse*. (The "Q" refers to the resonant quality of the optical cavity.) A laser operating in the *Q-switched* mode delivers less energy than the same laser operating in the *normal-pulse* mode, but the energy is delivered in a much shorter time period. Thus, *Q-switched* lasers are capable of delivering very high peak powers of several megawatts or even gigawatts. Most military lasers are *Q-switched* with a pulse duration of 10 to 30 ns and are used in target acquisition and fire control.

c. When the phases of different frequency modes are synchronized (i.e., "locked together"), the different modes will interfere with one another to generate a beat effect. The result will be a laser output which is observed as regularly spaced pulsations. Lasers operating in this fashion, *mode-locked*, usually produce trains of pulses, each having a duration of a few picoseconds to a few nanoseconds. A *mode-locked* laser can deliver higher peak powers than the same laser operating in the *Q-switched* mode.

d. Some lasers are able to operate continuously. This mode of operation is called *continuous wave* or *CW*. In this temporal mode of operation, the peak power is equal to the average power output (i.e., the beam irradiance is constant with time).

e. Pulsed lasers can be operated to produce repetitive pulses. The *pulse repetition frequency (PRF)* of a laser is the number of pulses which that laser produces in a given time. Lasers are now available with pulse repetition frequencies as high as several millions of pulses per second. There is an enormous variation in the pulse widths and pulse repetition frequencies which can be generated. Therefore, the specification of such pulse characteristics is extremely important in any evaluation of the interaction of laser radiation with biological systems.

**B-11. Transverse Electromagnetic Wave (TEM) Modes.** Because lasers developed from masers, it is only natural that some microwave terminology carried over into laser technology. Certain beam geometries appear to have transverse wave patterns across

the beam which are identified by TEM mode numbers. TEM comes from *transverse electromagnetic wave* (i.e., a wave pattern across the direction of propagation). Figure B-11 illustrates how some of the more common modes would look in cross-section. A laser operation in the TEM<sub>10</sub> mode can be considered as two lasers side by side, each with one-half the total power. *Longitudinal modes* in a resonant cavity influence the spectral quality of the laser output. Because longitudinal modes of a laser do not impact upon the hazards of a laser, they will not be discussed further.

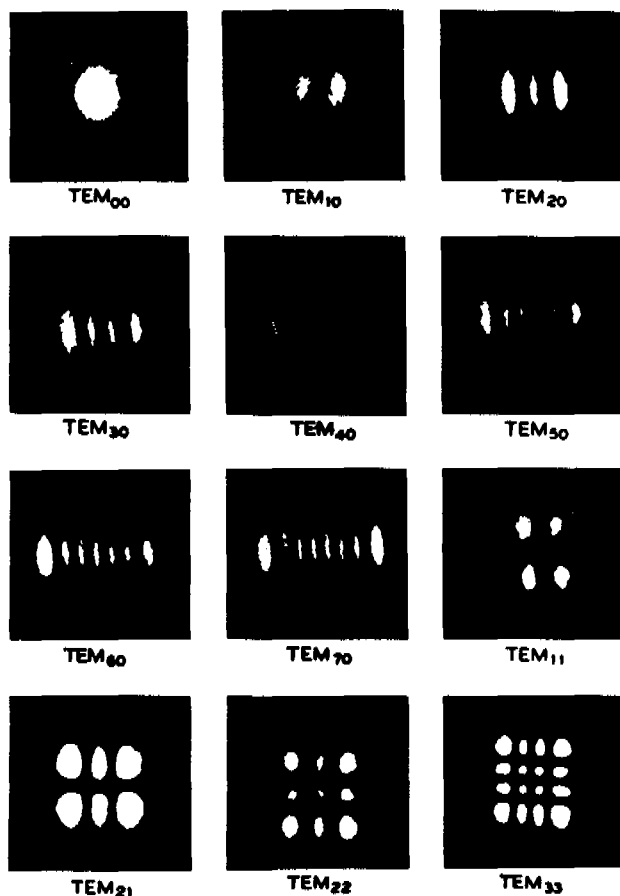

Figure B-11. Common TEM modes.

**B-12. Beam Diameter.** The laser beam diameter is measured at the exit aperture of the cavity. For a laser operating in the TEM<sub>00</sub> mode, the edge of the beam is variously defined as the circle where the irradiance or radiant exposure is  $1/2$ ,  $1/e$ ,  $1/e^2$ , or  $1/10$  of the maximum (fig B-12); for this bulletin, it is defined as  $1/e = 0.37$  of maximum. For a TEM<sub>00</sub> mode laser, 63 percent of the laser's output energy is within a circular area defined by the beam diameter.

**B-13. Beam Divergence.** *a.* Lasers are unable to produce perfectly collimated beams due to the wave nature of light. However, the divergence can be made much smaller than with any other source of optical radiation available to humans. The beam divergence

is the increase in beam diameter with increase in distance.

*b.* The divergence angle is expressed as the full angle,  $\phi$ . Figure B-13 shows the half-angle,  $\alpha$ .

*c.* The beam divergence is easily determined with the laser assumed operating in the simplest mode, TEM<sub>00</sub>, with all other modes negligibly small in comparison. When determining the beam diameter or the beam divergence, the beam should be defined at  $1/e$ -peak-irradiance points.

**B-14. Hot Spots.** *a.* *Hot spots* are defined as localized areas of the beam where the beam irradiance is much greater than the average across the beam. *Hot spots* are of considerable concern because it has been observed that under some conditions a *hot spot* may develop where the beam irradiance is 100 times higher than the average across the beam.

*b.* There are several sources of *hot spots*: Inhomogeneities in the laser cavity (i.e., areas where more energy is emitted than in other areas, imperfections in the mirrors and lenses of the laser system, and changes caused by atmospheric conditions).

*c.* Atmospheric inhomogeneities along the beam path produce lenticular effects (scintillation) which are responsible for atmospheric *hot spots*. Fog, rain, snow, dust, smoke, or other obscuring haze absorb and/or scatter the laser beam and do not cause *hot spots*; they tend to smooth out the beam profile.

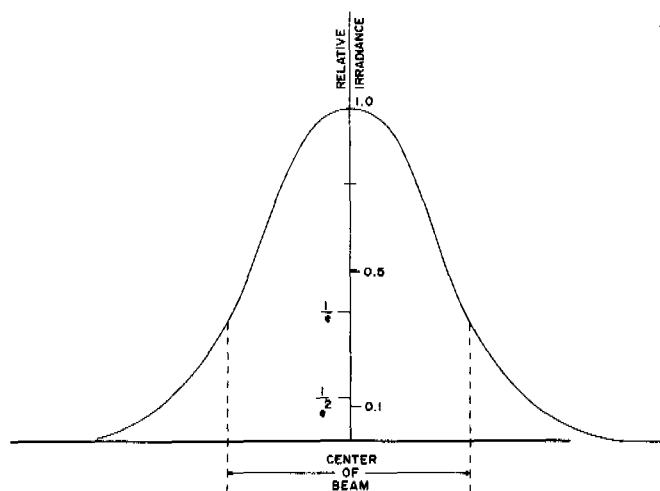

Figure B-12. Irradiance or radiant exposure at various points in the beam cross-section.

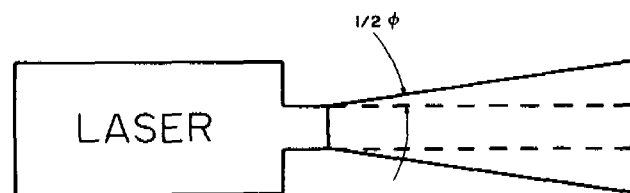

Figure B-13. Definition of divergence angle.

## APPENDIX C LASER EXPOSURE LIMITS

C-1. General. These exposure limits (ELs) are for maximum permissible exposure to laser radiation under conditions to which nearly all personnel may be exposed without adverse effects. The values should be used as guides in the control of exposures and should not be regarded as fine lines between safe

and dangerous levels. These values are based on the best available information from experimental studies. Tables C-1, C-2, and C-3 provide the complete list of laser ELs. Figures C-1 through C-6 provide graphs of exposure limits that may be difficult to calculate.

*Table C-1. Exposure limits for direct ocular exposures (intrabeam viewing) from a laser beam.*

Spectral region	Wavelength (nm)	Exposure time, † (seconds)	Exposure limit	Defining aperture (mm)
UV-C	200-302	$10^{-9} - 3 \times 10^4$	$3 \text{ mJ} \cdot \text{cm}^{-2}$	1
UV-B	303	$10^{-9} - 3 \times 10^4$	$4 \text{ mJ} \cdot \text{cm}^{-2}$	1
	304	$10^{-9} - 3 \times 10^4$	$6 \text{ mJ} \cdot \text{cm}^{-2}$	1
	305	$10^{-9} - 3 \times 10^4$	$10 \text{ mJ} \cdot \text{cm}^{-2}$	1
	306	$10^{-9} - 3 \times 10^4$	$16 \text{ mJ} \cdot \text{cm}^{-2}$	1
	307	$10^{-9} - 3 \times 10^4$	$25 \text{ mJ} \cdot \text{cm}^{-2}$	1
	308	$10^{-9} - 3 \times 10^4$	$40 \text{ mJ} \cdot \text{cm}^{-2}$	1
	309	$10^{-9} - 3 \times 10^4$	$63 \text{ mJ} \cdot \text{cm}^{-2}$	1
	310	$10^{-9} - 3 \times 10^4$	$100 \text{ mJ} \cdot \text{cm}^{-2}$	1
	311	$10^{-9} - 3 \times 10^4$	$160 \text{ mJ} \cdot \text{cm}^{-2}$	1
	312	$10^{-9} - 3 \times 10^4$	$250 \text{ mJ} \cdot \text{cm}^{-2}$	1
	313	$10^{-9} - 3 \times 10^4$	$400 \text{ mJ} \cdot \text{cm}^{-2}$	1
	314	$10^{-9} - 3 \times 10^4$	$630 \text{ mJ} \cdot \text{cm}^{-2}$	1
	UV-A	315-400‡	$10^{-9} - 10$	$0.56 t^{1/4} \text{ J} \cdot \text{cm}^{-2}$
315-400		$10 - 10^3$	$1.0 \text{ J} \cdot \text{cm}^{-2}$	1
315-400		$10^3 - 3 \times 10^4$	$1.0 \text{ mW} \cdot \text{cm}^{-2}$	1

} or  $0.56 t^{1/4} \text{ J} \cdot \text{cm}^{-2}$

(Table C-1 continued on page C-2)

Table C-1. Exposure limits for direct ocular exposures (intrabeam viewing) from a laser beam—Continued.

Spectral region	Wavelength (nm)	Exposure time, † (seconds)	Exposure limit	Defining aperture (mm)
Light	400-700	$10^{-9} - 1.8 \times 10^{-5}$	$5 \times 10^{-7} \text{ J} \cdot \text{cm}^{-2}$	7
	400-700	$1.8 \times 10^{-5} - 10$	$1.8t^{3/4} \text{ mJ} \cdot \text{cm}^{-2}$	7
	400-550	$10 - 10^4$	$10 \text{ mJ} \cdot \text{cm}^{-2}$	7
	550-700	$10 - T_1$	$1.8t^{3/4} \text{ mJ} \cdot \text{cm}^{-2}$	7
	550-700	$T_1 - 10^4$	$10 C_B \text{ mJ} \cdot \text{cm}^{-2}$	7
	400-700	$10^4 - 3 \times 10^4$	$C_B \mu\text{W} \cdot \text{cm}^{-2}$	7
IR-A	701-1049	$10^{-9} - 1.8 \times 10^{-5}$	$5 C_A C_p \times 10^{-7} \text{ J} \cdot \text{cm}^{-2}$	7
	701-1049	$1.8 \times 10^{-5} - 10^3$	$1.8 C_A t^{3/4} \text{ mJ} \cdot \text{cm}^{-2}$	7
	1050-1400	$10^{-9} - 5 \times 10^{-5}$	$5 C_p \times 10^{-6} \text{ J} \cdot \text{cm}^{-2}$	7
	1050-1400	$5 \times 10^{-5} - 10^3$	$9t^{3/4} \text{ mJ} \cdot \text{cm}^{-2}$	7
	701-1400	$10^3 - 3 \times 10^4$	$320 C_A \mu\text{W} \cdot \text{cm}^{-2}$	7
IR-B&C	$1.4 \cdot 10^3 \mu\text{m}t$	$10^{-9} - 10^{-7}$	$10^{-2} \text{ J} \cdot \text{cm}^{-2}$	1,11*
	$1.4 \cdot 10^3 \mu\text{m}t$	$10^{-7} - 10$	$0.56t^{1/4} \text{ J} \cdot \text{cm}^{-2}$	1,11*
	$1.4 \cdot 10^3 \mu\text{m}$	>10	$0.1 \text{ W} \cdot \text{cm}^{-2}$	1,11*

Legend: \* - 1 mm for  $1400\text{-}10^5$  nm; 11 mm  $10^5 - 10^6$  nm

† - the exposure limit at 1540 (Erbium) for a single-pulse exposure (<1  $\mu\text{s}$ ) is  $1 \text{ J} \cdot \text{cm}^{-2}$ ;

‡ - or not exceed  $1 \text{ J} \cdot \text{cm}^{-2}$  over 24 hours

Notes:

- To aid in the determination of exposure limits for exposure durations requiring calculations of fractional powers, figures C-1, C-2, and C-3 may be used.
- $C_A = 10^{[0.002(\lambda - 700)]}$  for  $\lambda = 700\text{-}1049$  nm;  $C_A = 1$  for  $\lambda = 400\text{-}700$  nm;  $C_A = 5$  for  $\lambda = 1050\text{-}1400$  nm (see fig C-4).
- $C_B = 1$  for  $\lambda = 400\text{-}550$  nm (see fig C-7).
- $C_B = 10^{[0.015(\lambda - 550)]}$  for  $\lambda = 550\text{-}700$  nm.
- $T_1 = 10 \times 10^{[0.020(\lambda - 550)]}$  for  $\lambda = 550\text{-}700$  nm.
- $C_p = 1/\sqrt{F}$  for PRF  $\leq 100$  Hz, for PRFs from  $> 100$  Hz  $\leq 1000$  Hz, see figure C-5, for PRFs  $> 1000$  Hz  $C_p = 0.06$ . These values of  $C_p$  only apply for  $t \leq 10 \mu\text{s}$ . For  $t > 10 \mu\text{s}$ , see paragraph C-5.

Table C-2. Exposure Limits for Viewing a Diffuse Reflection of a Laser Beam or an Extended Source Laser.

Spectral region	Wavelength (nm)	Exposure time, t (seconds)	Exposure limit
Light	400-700	$10^{-9} - 10$	$10 t^{1/3} \text{ J}\cdot\text{cm}^{-2}\cdot\text{sr}^{-1}$
	400-550	$10 - 10^4$	$21 \text{ J}\cdot\text{cm}^{-2}\cdot\text{sr}^{-1}$
	550-700	$10 - T_1$	$3.83 t^{3/4} \text{ J}\cdot\text{cm}^{-2}\cdot\text{sr}^{-1}$
	550-700	$T_1 - 10^4$	$21 C_B \text{ J}\cdot\text{cm}^{-2}\cdot\text{sr}^{-1}$
	400-700	$10^4 - 3 \times 10^4$	$2.1 C_B \text{ mW}\cdot\text{cm}^{-2}\cdot\text{sr}^{-1}$
Near infrared	700-1400	$10^{-9} - 10$	$10 C_A t^{1/3} \text{ J}\cdot\text{cm}^{-2}\cdot\text{sr}^{-1}$
	700-1400	$10 - 10^3$	$3.83 C_A t^{3/4} \text{ J}\cdot\text{cm}^{-2}\cdot\text{sr}^{-1}$
	700-1400	$10^3 - 3 \times 10^4$	$0.64 C_A \text{ W}\cdot\text{cm}^{-2}\cdot\text{sr}^{-1}$

Notes:

 $C_A$ ,  $C_B$ , and  $T_1$  are the same as in footnote to table C-1.

Table C-3. Exposure Limits for Skin Exposure From a Laser Beam.

Spectral region	Wavelength	Exposure time, t (seconds)	Exposure limit
UV	200 to 400 nm	$10^{-9} - 3 \times 10^4$	Same as table C-1
Light & infrared A	400 to 1400 nm	$10^{-9} - 10^{-7}$	$2 C_A \times 10^{-2} \text{ J}\cdot\text{cm}^{-2}$
do	do	$10^{-7} - 10$	$1.1 C_A t^{1/4} \text{ J}\cdot\text{cm}^{-2}$
do	do	$10 - 3 \times 10^4$	$0.2 C_A \text{ W}\cdot\text{cm}^{-2}$
Infrared B & C	1.4 $\mu\text{m}$ to 1 mm	$10^{-9} - 3 \times 10^4$	Same as table C-1*

Note:

To aid in the determination of exposure limit for exposure durations requiring calculations of fractional powers, figure C-6a may be used. The limiting aperture for all of these ELs is 1 mm for wavelengths less than 0.1 mm. The limiting aperture for wavelengths greater than 0.1 mm is 11 mm.

\* Whole-body exposure should be limited to  $10 \text{ mW}\cdot\text{cm}^{-2}$ . The above limits refer to a laser beam having a cross-sectional area less than  $100 \text{ cm}^2$ .

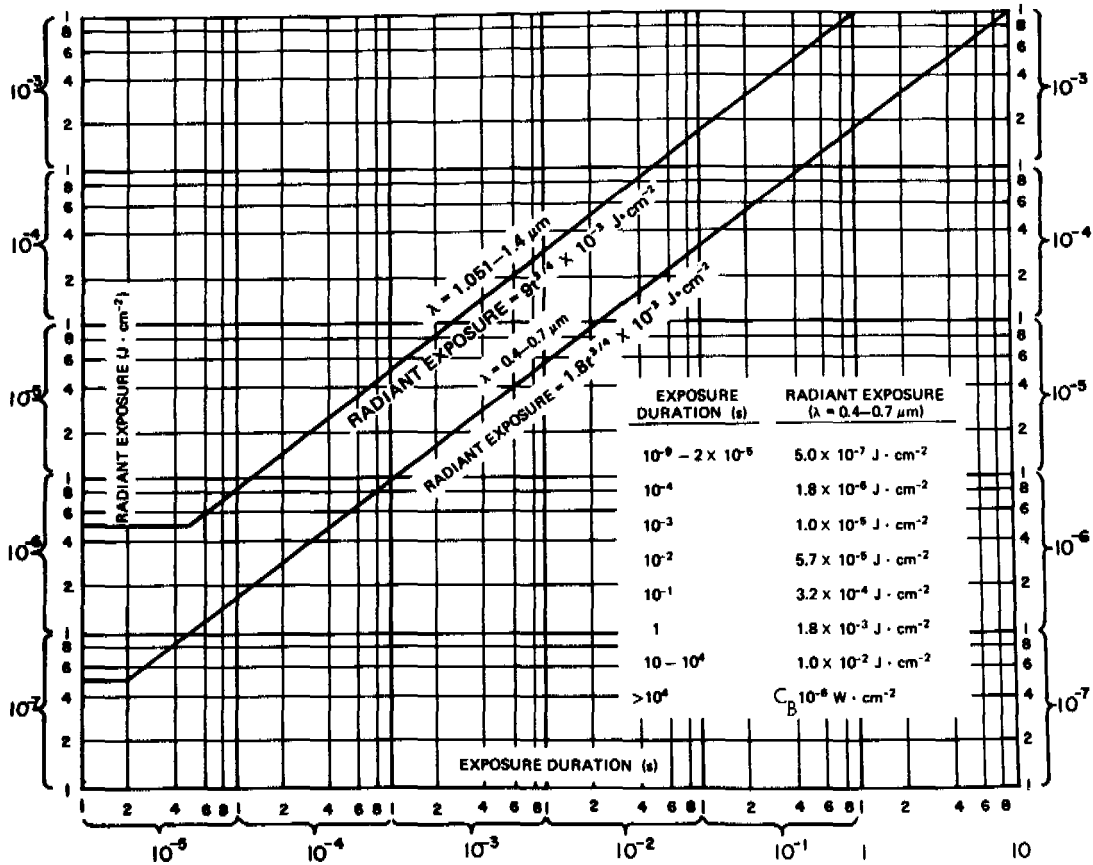

Exposure limits for intrabeam viewing of pulsed IR-A (700-1400 nm) laser radiation are obtained by multiplying the value in the graph by C<sub>A</sub>. For correction factor information at wavelengths between 0.7 μm and 1.4 μm, see table C-1.

Figure C-1a. Protection standard for intrabeam viewing of pulsed visible (400-700 nm) laser radiation.

This material is reproduced with permission from American National Standard for the Safe Use of Lasers, ANSI Z136.1-1980, copyright 1981 by the American National Standards Institute, copies of

which may be purchased from the American National Standards Institute at 1430 Broadway, New York, New York 10018.

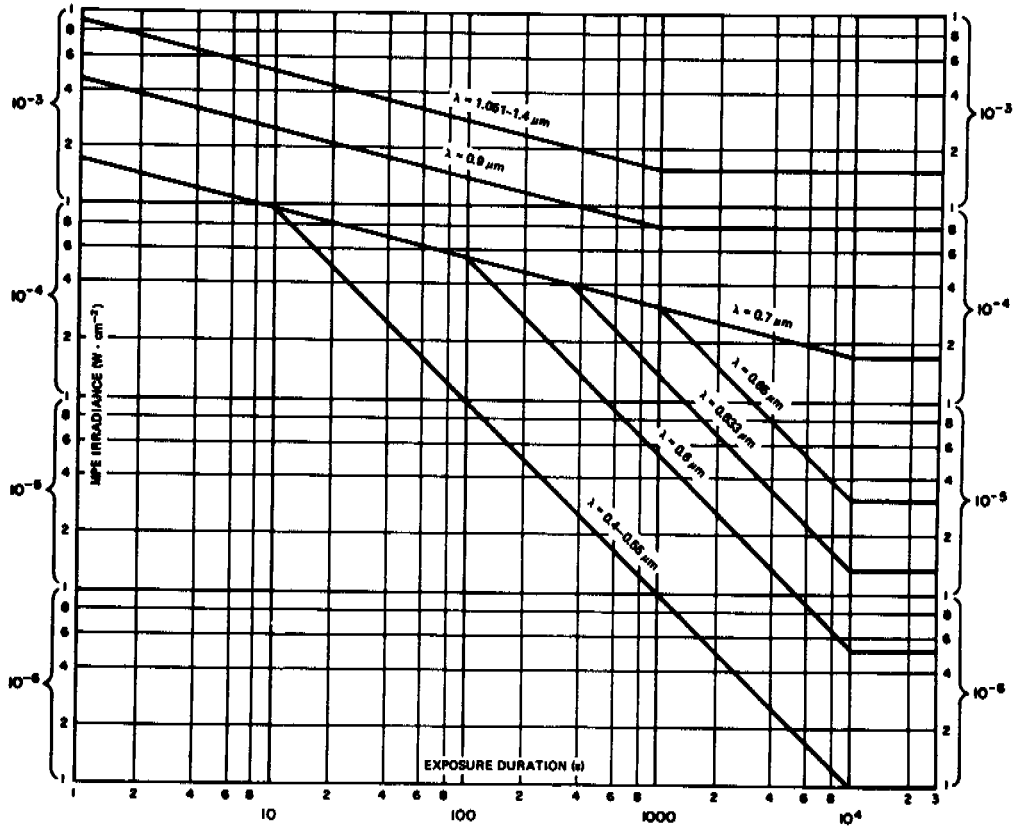
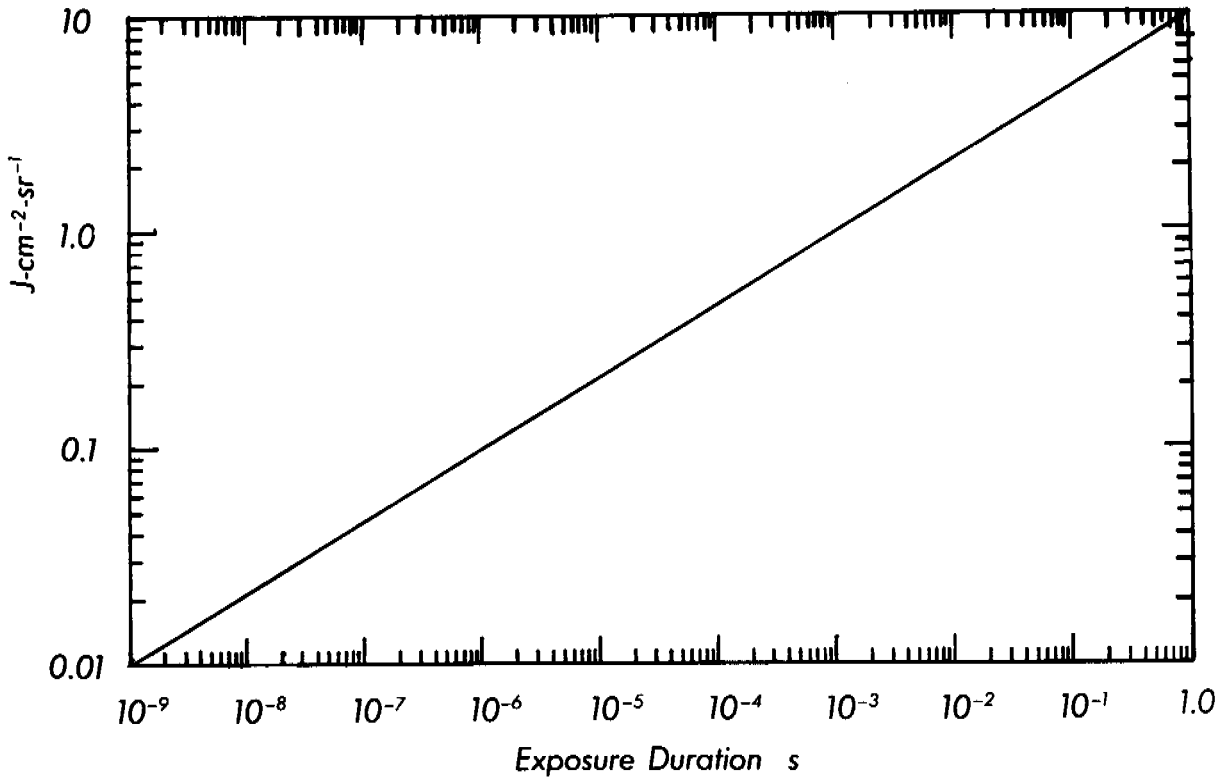

Figure C-1b. Exposure limit for intrabeam viewing of CW visible (400–700 nm) and IR-A (750, 900, and 1060–1400 nm) laser radiation.

This material is reproduced with permission from American National Standard for the Safe Use of Lasers, ANSI Z136.1-1980, copyright 1981 by the American National Standards Institute, copies of

which may be purchased from the American National Standards Institute at 1430 Broadway, New York, New York 10018.



To obtain exposure limit for wavelengths 700–1400 nm, multiply by  $C_A$ .

Figure C-2a. Exposure limit for extended sources or diffuse reflections of pulsed laser radiation (400–700 nm).



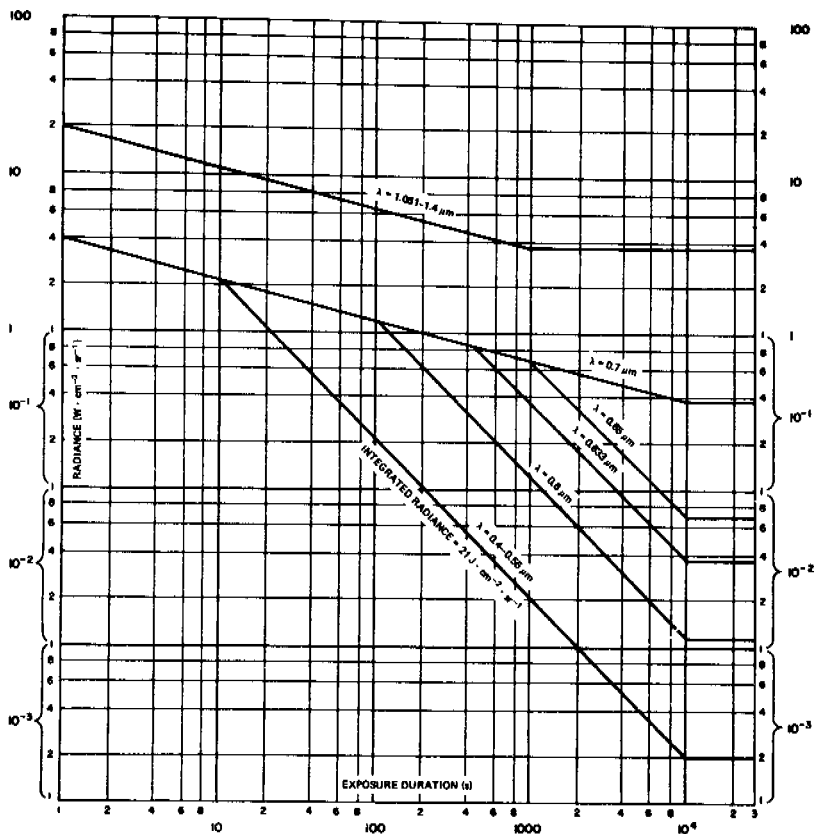
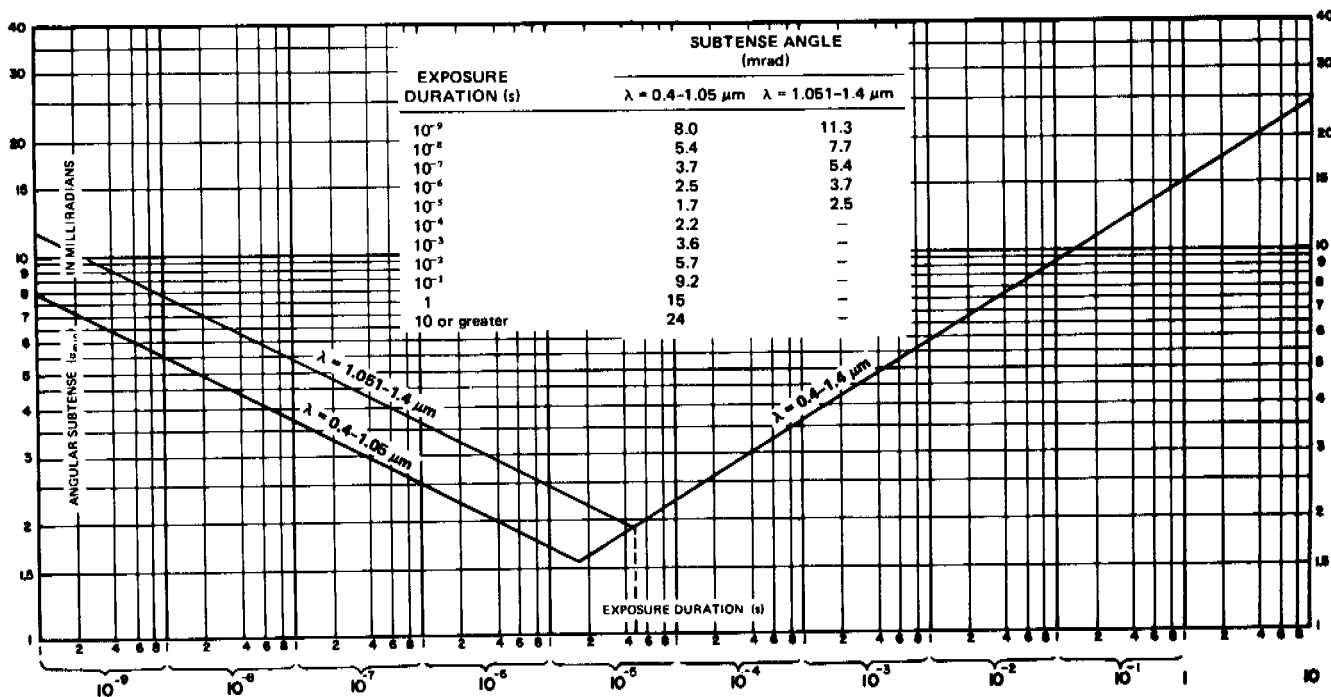

Figure C-2b. Exposure limit for extended sources or diffuse reflections of CW visible (400-700 nm) and IR-A (850, 900, and 1060-1400 nm) laser radiation.

This material is reproduced with permission from American National Standard for the Safe Use of Lasers, ANSI Z136.1-1980, copyright 1981 by the American National Standards Institute, copies of

which may be purchased from the American National Standards Institute at 1430 Broadway, New York, New York 10018.



Sources whose angular subtend are less than  $\alpha_{min}$  are considered collimated; those greater than or equal to  $\alpha_{min}$  are considered extended sources.

Extended sources have an angular subtense or apparent visual angle  $>\alpha_{min}$ . Angular subtenses (apparent visual angles)  $<\alpha_{min}$  are considered intrabeam viewing.

Figure C-3. Limiting angular subtense of an extended source ( $\alpha_{min}$ ).

This material is reproduced with permission from American National Standard for the Safe Use of Lasers, ANSI Z136.1-1980, copyright 1981 by the American National Standards Institute, copies of

which may be purchased from the American National Standards Institute at 1430 Broadway, New York, New York 10018.

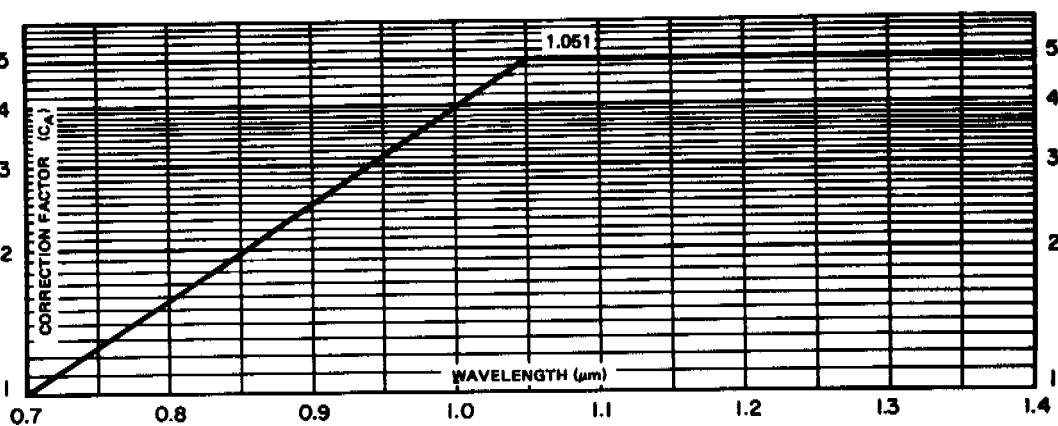

NOTE:  $C_A = 1$  for  $\lambda = 0.4-0.7 \mu\text{m}$ ;  
 $C_A = 102.0(\lambda - 0.7)$  for  $\lambda = 0.7-1.05 \mu\text{m}$   
 $C_A = 5$  for  $\lambda = 1.051-1.4 \mu\text{m}$

Figure C-4. Correction factor  $C_A$  for wavelengths 0.7-1.4  $\mu\text{m}$ .

This material is reproduced with permission from American National Standard for the Safe Use of Lasers, ANSI Z136.1-1980, copyright 1981 by the American National Standards Institute, copies of

which may be purchased from the American National Standards Institute at 1430 Broadway, New York, New York 10018.

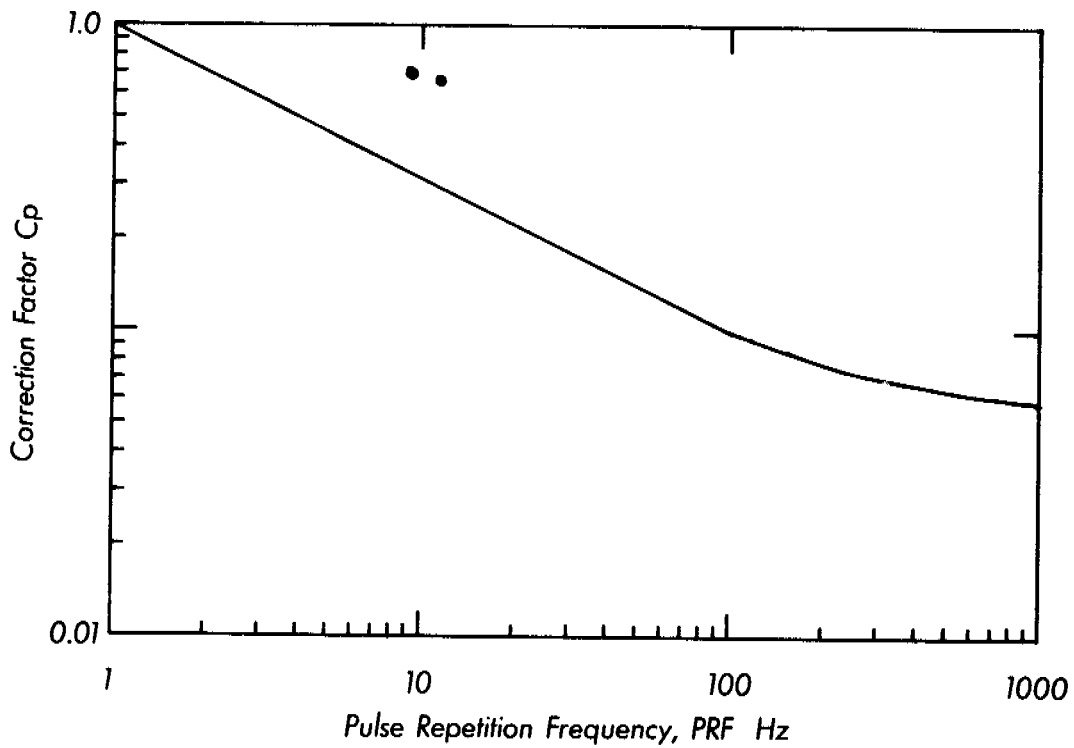

The exposure limit for a single pulse of a pulse train is multiplied by the above correction factor.  $C_p$  for PRF greater than 1000 Hz is 0.06.

Figure C-5. Correction factor  $C_p$  for repetitively pulsed lasers having pulse durations less than  $10^{-6}$  second.

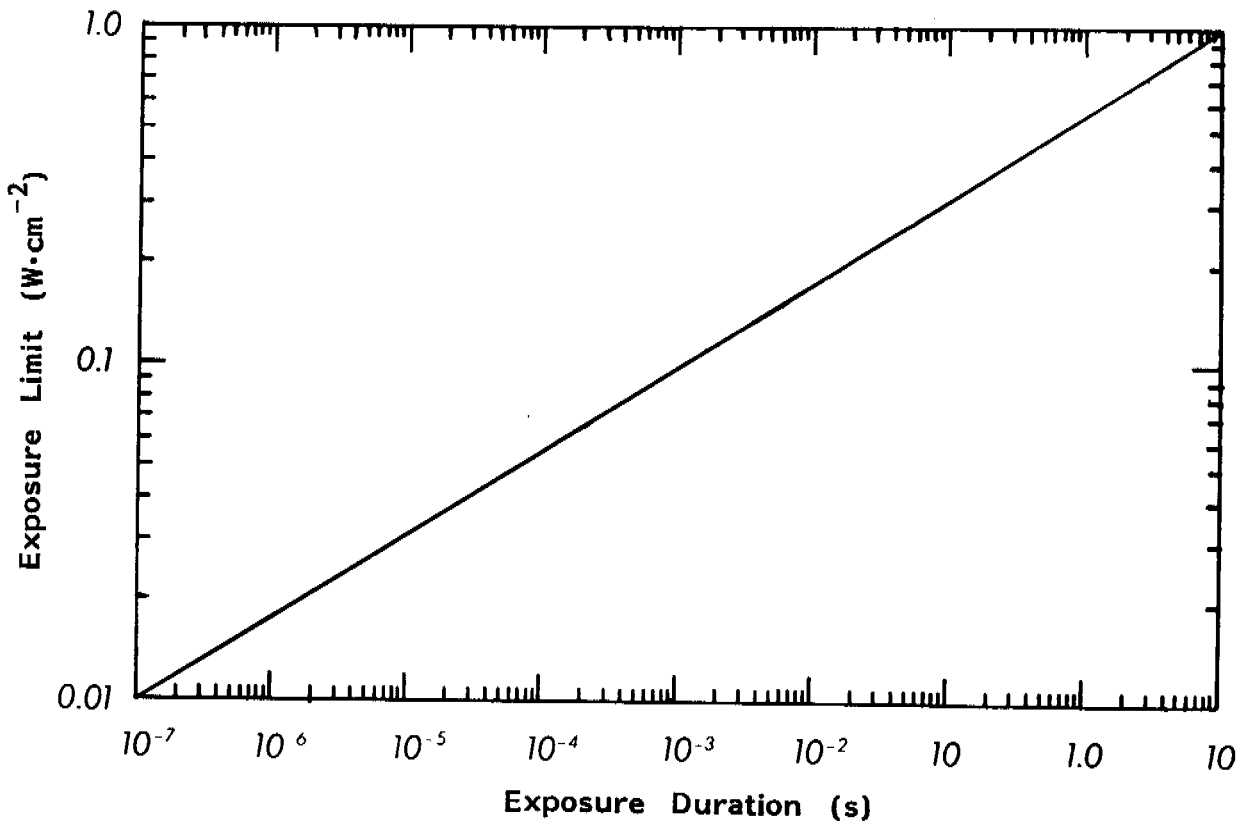

Exposure limits for skin exposure (400–1400 nm) are twice these values.

Figure C-6a. Exposure limit for pulsed laser exposure of skin and eyes for far-infrared radiation (wavelengths greater than 1400 nm).

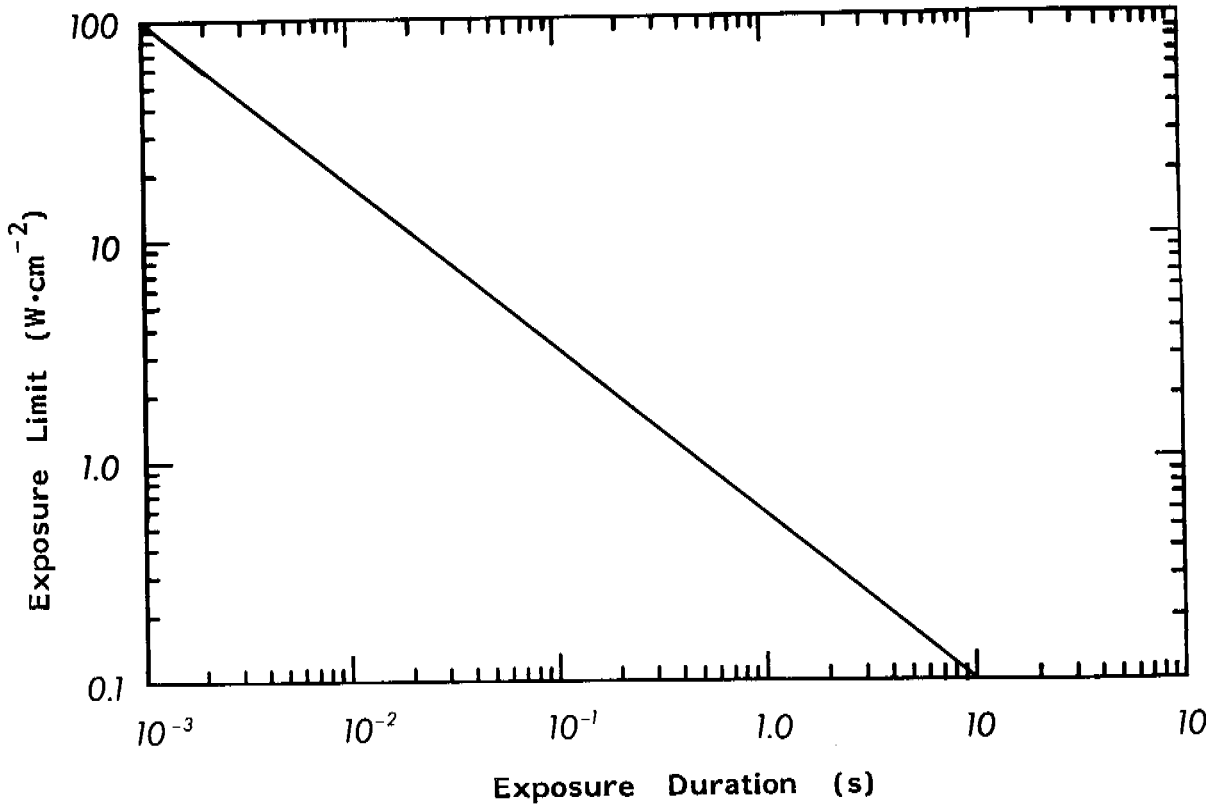

Exposure limits for skin exposure (400-1400 nm) are twice the values given in the graph.

Figure C-6b. Exposure limit for CW laser exposure of skin and eyes for far-infrared radiation (wavelengths greater than 1400 nm).

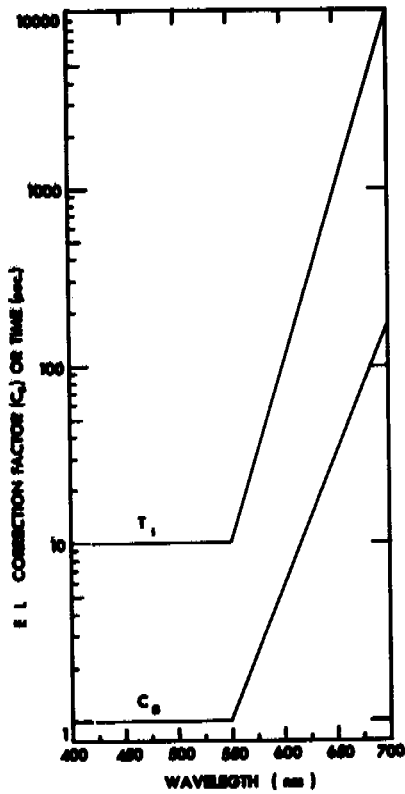

Figure C-7. Correction factors  $C_B$  and  $T_1$  for wavelengths 0.55-0.7  $\mu m$ .

**C-2. Limiting Apertures.** Those exposure limits expressed as a radiant exposure or irradiance in this section may be averaged over an aperture of 1 mm except for the exposure limits for the eye in the spectral range of 400 to 1400 nm, which should be averaged over a 7-mm limiting aperture (pupil). No modification of the exposure limits is permitted for pupil sizes less than 7 mm.

**C-3. Extended Sources.** Those exposure limits for *extended sources* apply to sources that subtend an angle greater than  $\alpha_{\min}$  (fig C-3) that varies with exposure duration. This angle is not the beam divergence of the sources.

**C-4. Correction Factor A ( $C_A$ ).** All exposure limits in tables C-1, C-2, and C-3 are to be used as given for wavelengths 400 nm to 700 nm. Exposure limits at wavelengths between 700 nm and 1050 nm increase by a uniformly extrapolated factor  $C_A$  as shown in figure C-4.

**C-5. Repetitively Pulsed Lasers.** Due to the wide variety of pulsed laser systems and the relative lack of biological data for some spectral regions, caution shall be used in the evaluation of such exposures. Exposure to a scanning laser system may also be evaluated as a series of pulses received by the eye or skin. The exposure limit for irradiance or radiant exposure may be determined by the following guidelines.

*a.* Pulsed lasers having a duration less than 10  $\mu\text{s}$ —

(1) Determine the exposure limit for a single pulse in the pulse train.

(2) Determine the repetitively pulsed correction factor ( $C_P$ ) based on the minimum pulse-to-pulse spacing in time from figure C-5.

#### NOTE

For PRFs of 1 to 100 Hz,  $C_P$  equals the inverse of the square root of the PRF.

(3) An alternative approach to calculating  $C_P$  should be used only when calculating the exposure to a series of pulses lasting less than 10 s. Using a value of  $C_P$  equal to the inverse of the fourth root of the total maximum number of pulses ( $n$ ), a person might receive in a 10 s period of time ( $C_P = n^{-1/4}$ ).

(4) A complicated series of pulses lasting longer than 10 s may have a  $C_P$  calculated from figure C-5 based on the average PRF.

(5) All pulses emitted within 18  $\mu\text{s}$  should have their energies added and counted as one pulse.

(6) All groupings of pulses from 18  $\mu\text{s}$  to the maximum exposure duration a person would reasonably be expected to receive should have an emission limit calculated separately. Calculate the emission limit as if each group of pulses were actually one pulse with a pulse duration equal to the duration of the group of pulses. The single-pulse emission limit is then determined by dividing the emission limit for the group by the number of pulses in the group. Of those calculated, the most conservative (lowest value) single-pulse emission limit should be used.

*b.* Pulsed lasers having a duration greater than 10  $\mu\text{s}$ —

(1) Determine the total number of pulses in an individual exposure ( $n$ ). A 10 s time period may be used in most cases when the exact exposure time is unknown.

(2) Multiply the number of pulses by the length of each pulse ( $nt$ ).

(3) Determine the exposure limit [ $EL(nt)$ ] for a pulse of duration ( $nt$ ).

(4) Determine the single-pulse exposure limit [ $EEL(\text{single pulse})$ ] by dividing the exposure limit determined above by the number of pulses as shown by the following formula:

$$EL(\text{single pulse}) = \frac{EL(nt)}{n}$$

## APPENDIX D

### LASER HAZARD CLASSIFICATION

**D-1. General.** Classification of most all lasers requires the following radiometric parameters:

- a. Wavelength(s) or wavelength range.
- b. For CW or repetitively pulsed lasers: average power output and limiting exposure duration inherent to the design of the laser or laser system,  $T_{\max}$ .
- c. For pulsed lasers: Total energy/pulse (or peak power), pulse duration, PRF, and emergent beam radiant exposure.

**D-2. Extended Source Lasers.** Classification of extended source lasers or laser systems (e.g., some injection laser diode arrays, and those lasers having a permanent diffuser within the output optics) require the laser source radiance or integrated radiance and the maximum viewing angular subtense. These are in addition to the parameters listed in table D-1.

**D-3. Accessible Emission Limit (AEL) for Class 1.** In a *worst-case* analysis of a laser's potential for producing injury, consider not only the laser output irradiance or radiant exposure, but also whether a hazard would exist if the total laser output were concentrated within the defining aperture for the applicable exposure limit. For instance, the unfocused beam of a far-infrared CW laser would not normally be hazardous if the beam irradiance were less than  $0.1 \text{ W}\cdot\text{cm}^{-2}$ ; however, if the output power were 100 W and the beam were focused at some location to a 1-mm spot, a serious hazard could exist. This laser shall be evaluated in two different ways depending upon whether or not the laser itself is considered an *extended source* (an unusual case):

a. For most lasers, the AEL for Class 1 is the product of:

- (1) The intrabeam exposure limit for the eye (table C-1) for the limiting exposure duration  $T_{\max}$ , and
- (2) The circular area of the defining aperture for the exposure limit (table C-1), in  $\text{cm}^2$ .

b. For extended-source lasers (such as laser arrays, laser diodes, and diffused-output lasers) that emit in the spectral range of 0.4 to 1.4  $\mu\text{m}$ , the AEL Class 1 is determined by that power or energy output so that the source radiance does not exceed the exposure limit (table C-2) if the source were viewed at the minimum viewing distance. Theoretically, a perfect optical viewing system has an entrance aperture of 8 cm which collects the entire laser beam output and which has a 7-mm exit pupil. If this definition is difficult to apply, the definition in *a* above may be applied and will result in a conservative AEL for Class 1.

**D-4. Classification of Multiwavelength Lasers.** The classification of laser devices that can potentially emit at numerous wavelengths shall be based on the most hazardous possible operation.

**D-5. Laser Device Hazard Classification Definitions.** a. *Class 1.* Any laser device that cannot emit laser radiation levels in excess of the AEL for the maximum possible duration inherent to the design of the laser or laser system. The exemption from hazard controls strictly applies to emitted laser radiation hazards and not to other potential hazards.

b. *Class 2.*

(1) Visible (400 nm to 700 nm) CW laser devices that can emit a power exceeding the AEL for Class 1 for the maximum possible duration inherent to the design of the laser or laser system but not exceeding 1 mW.

(2) Visible (400 nm to 700 nm) repetitively pulsed laser devices that can emit a power exceeding the appropriate AEL for Class 1 for the maximum possible duration inherent to the design of the laser device but not exceeding the AEL for a 0.25 s exposure.

c. *Class 2a.* A visible (400 nm to 700 nm) laser or laser system that is not intended for intrabeam viewing and does not exceed the exposure limit for 1000 s of viewing time.

d. *Class 3a.* Class 3a lasers or laser systems have—

(1) An accessible output power or energy between 1 and 5 times the lowest appropriate AEL for Class 2 for visible wavelengths, and between 1 and 5 times the AEL for Class 1 for all other wavelengths.

(2) Do not exceed the appropriate exposure levels as measured over the limiting aperture ( $2.5 \text{ mW}\cdot\text{cm}^{-2}$  for visible CW lasers).

e. *Class 3b.*

(1) *Infrared (1.4  $\mu\text{m}$  to 1 mm) and ultraviolet (200 nm to 400 nm) laser devices.* Emit a radiant power in excess of the AEL Class 1 for the maximum possible duration inherent to the design of the laser device. Cannot emit an average radiant power of 0.5 W or greater for  $T_{\max}$  greater than 0.25 s, or a radiant exposure of  $10 \text{ J}\cdot\text{cm}^{-2}$  within an exposure time of 0.25 s or less.

(2) *Visible (400 nm to 700 nm) CW or repetitive pulsed laser devices.* Produce a radiant power in excess of the AEL Class 1 for a 0.25 s exposure (1 mW for a CW laser). Cannot emit an average radiant power of 0.5 W or greater for  $T_{\max}$  greater than 0.25 s.

(3) *Visible and near-infrared (400 nm to 1400 nm) pulsed laser devices.* Emit a radiant energy in

# TB MED 524

excess of the AEL Class 1. Cannot emit a radiant exposure that exceeds that required to produce a hazardous diffuse reflection as given in table D-1.

(4) *Near-infrared (700 nm to 1400 nm) CW laser devices or repetitively pulsed laser devices.* Emit power in excess of the AEL for Class 1 for the maximum duration inherent in the design of the laser device. Cannot emit an average power of 0.5 W or greater for periods in excess of 0.25 s.

*f. Class 4.*

(1) *Ultraviolet (200 nm to 400 nm) and infrared (1.4 μm to 1 mm) laser devices.* Emit an average power

er of 0.5 W or greater for periods greater than 0.25 s, or a radiant exposure of 10 J·cm<sup>-2</sup> within an exposure duration of 0.25 s or less.

(2) *Visible (400 nm to 700 nm) and near-infrared (700 nm to 1400 nm) laser devices.* Emit an average power of 0.5 W or greater for periods greater than 0.25 s, or a radiant exposure in excess of that required to produce a hazardous diffuse reflection as given in table D-1.

**D-6. Examples.** Tables D-2 and D-3 provide examples of hazard classification for some typical lasers.

*Table D-1. Maximum Allowable Radiant Intensity from a Diffuse Surface Reflection as Measured at the Reflecting Surface for Extended Sources: Angular Subtense α<sub>min</sub>. (See paragraph C-3 for explanations.)*

Typical diffuse reflection cases for visible radiation (C<sub>A</sub> = 1 for λ = 400 to 700 nm) (for wavelengths between 0.7 and 1.4 μm use appropriate correction factors from figure C-4).

Duration of exposure (seconds)	Exposure limit at cornea (J·cm <sup>-2</sup> sr <sup>-1</sup> ) See figure C-2a for graphic presentation of this column	Limiting angle, α <sub>min</sub> (see figure C-3)	Permissible laser beam radiant exposure incident on the diffuse reflecting surfaces (J·cm <sup>-2</sup> ) Values in columns 4, 5, 6 = values in column 2 × $\frac{\pi}{\rho}$		
			Reflectance(ρ) = 100%	Reflectance(ρ) = 50%	Reflectance(ρ) = 10%
10 <sup>-9</sup>	1.0 × 10 <sup>-2</sup>	8.0	3.1 × 10 <sup>-2</sup>	6.3 × 10 <sup>-2</sup>	3.1 × 10 <sup>-1</sup>
10 <sup>-8</sup>	2.2 × 10 <sup>-2</sup>	5.4	6.8 × 10 <sup>-2</sup>	1.4 × 10 <sup>-1</sup>	6.8 × 10 <sup>-1</sup>
10 <sup>-7</sup>	4.6 × 10 <sup>-2</sup>	3.7	1.5 × 10 <sup>-1</sup>	2.9 × 10 <sup>-1</sup>	1.5
10 <sup>-6</sup>	1.0 × 10 <sup>-1</sup>	2.5	3.1 × 10 <sup>-1</sup>	6.3 × 10 <sup>-1</sup>	3.1
10 <sup>-5</sup>	2.2 × 10 <sup>-1</sup>	1.7	6.8 × 10 <sup>1</sup>	1.4	6.8
10 <sup>-4</sup>	4.6 × 10 <sup>-1</sup>	2.2	1.5	2.9	15
10 <sup>-3</sup>	1.0	3.6	3.1	6.3	31
10 <sup>-2</sup>	2.2	5.7	6.8	14	68
10 <sup>-1</sup>	4.6	9.2	15	29	150
1	10	15	31	63	310
10 to 10 <sup>4</sup>	22	24	68	140	680

Note:

The actual radiant exitance (the light reflected from a diffuse surface) may be calculated by multiplying the radiant exposure or irradiance of the beam impinging upon the surface by the reflectance (a property of the material). These values may be approximately tripled for conditions of bright ambient light.

*Table D-2. Typical Laser Classification—CW Lasers.*

Wavelength range	Laser	Wavelengths	Exempt-Class 1	Low power-Class 2	Medium power-Class 3	High power-Class 4
U V (100-280 nm)	CW Neodymium: YAG-Quadrupled	266 nm	≤0.8 nW* for 8 hours	N/A	>Class I but ≤0.5 W	>0.5 W
U V (315-400 nm)	Helium-Cadmium	325 nm only	≤8 μW for 8 hours	N/A	>Class I but ≤0.5 W	>0.5 W
	Argon	351.1 & 363.8 nm only				
	Krypton	350.7 & 356.4 nm only				
Visible (400-700 nm)	Helium-Cadmium	441.6 nm only	≤0.4 μW			
	Argon (Visible)	457.9, 476.5 488, 514.5 nm, etc.				
	Helium-Selenium	460.4-1260 nm				
	CW Neodymium: YAG (Doubled) Helium-Neon Krypton	532 nm 632.8 nm 647.1, 530.9, 676.4 nm, etc.	≤6.6 μW	>Class I but ≤1 mW	>Class II but ≤0.5 W	>0.5W

Table D-2. Typical Laser Classification—CW Lasers—Continued.

Wavelength range	Laser	Wavelengths	Exempt-Class 1	Low power-Class 2	Medium power-Class 3	High power-Class 4
Near I R (0.7-1.4 $\mu\text{m}$ )	CW Gallium-Arsenide	905 nm (20°C)	0.31 mW	N/A	>Class I but $\leq 0.5$ W	>0.5 W
	CW Neodymium YAG Helium-Neon	1064 nm 1.08, 1.152 $\mu\text{m}$ only	0.62 mW 0.62 mW			
Far I R (1.4-100 $\mu\text{m}$ )	Helium-Neon Hydrogen-Fluoride Carbon-Monoxide Carbon-Dioxide	4-6 $\mu\text{m}$ 5.0-5.5 $\mu\text{m}$ 10.6 $\mu\text{m}$ 3.39 only	$\leq 0.8$ mW	N/A	>Class I but $\leq 0.5$ W	>0.5 W
Far I R (0.1-1 mm)	Water Vapor Hydrogen-Cyanide	118 $\mu\text{m}$ 337 $\mu\text{m}$	78.5 mW	N/A	>Class I but $\leq 0.5$ W	>0.5 W

\* Assumes no mechanical or electrical design incorporated into laser system to prevent exposures from lasting to  $T_{\text{max}} = 8$  hours (one workday); otherwise  $P_{\text{exempt}}$  could be larger than tabulated.

Table D-3. Typical Laser Classification—Single Pulse Lasers.

Wavelength range	Laser	Wavelengths	Pulse duration	Exempt-Class 1	Medium power-Class 3	High power-Class 4
U.V.	Neodymium: YAG QSW (Quadrupled) Ruby (Doubled)	266 nm	10-30 ns (Q-Sw)	No Criteria	$\leq 10$ J $\cdot\text{cm}^{-2}$	>10 J $\cdot\text{cm}^{-2}$
		347.1 nm	30 ns (Q-Sw)	57.9 $\mu\text{J}$	$\leq 10$ J $\cdot\text{cm}^{-2}$	>10 J $\cdot\text{cm}^{-2}$
Visible (400-700 nm)	Neodymium: YAG (Doubled) Ruby	532 nm	20 ns (Q-Sw)	$\leq 0.2$ $\mu\text{J}$	>Class I but $\leq 85$ mJ $\cdot\text{cm}^{-2}$	>85 mJ $\cdot\text{cm}^{-2}$
		694.3 nm	20 ns (Q-Sw)	$\leq 0.2$ $\mu\text{J}$	>Class I but $\leq 85$ mJ $\cdot\text{cm}^{-2}$	>85 mJ $\cdot\text{cm}^{-2}$
	Ruby (Long Pulse)	694.3 nm	1 ms	$\leq 4.0$ $\mu\text{J}$	>Class I but $\leq 3.1$ J $\cdot\text{cm}^{-2}$	>3.1 J $\cdot\text{cm}^{-2}$
	Rhodamine 6G (Dye Laser)	450-650 nm	1 $\mu\text{s}$	$\leq 0.2$ $\mu\text{J}$	>Class I but $\leq 0.31$ J $\cdot\text{cm}^{-2}$	>0.31 J $\cdot\text{cm}^{-2}$
I.R. (700 nm-1 mm)	Neodymium: YAG	1064 nm	20 ns (Q-Sw)	$\leq 2$ $\mu\text{J}$	>Class I but $\leq 0.42$ J $\cdot\text{cm}^{-2}$	>0.42 J $\cdot\text{cm}^{-2}$
	Erbium: Glass	1.54 $\mu\text{m}$	10 - 100 ns (Q-Sw)	$\leq 7.85$ mJ	>Class I but $\leq 10$ J $\cdot\text{cm}^{-2}$	>10 J $\cdot\text{cm}^{-2}$
	Carbon Dioxide	10.6 $\mu\text{m}$	1-100 ns (Q-Sw)	$\leq 78.5$ $\mu\text{J}$	>Class I but $\leq 10$ J $\cdot\text{cm}^{-2}$	>10 J $\cdot\text{cm}^{-2}$



## APPENDIX E DETAILED TECHNICAL HAZARD ANALYSIS

### Section I. GENERAL EVALUATIONS

**E-1. Introduction.** As the eye is the structure most sensitive to damage from the laser beam in almost all cases, hazard evaluations based upon exposure limits for the eye can be applied to the rest of the body.

**E-2. Viewing the Primary Beam (Direct Intrabeam Viewing).** The worst possible situation would exist if the eye were focused at infinity and the beam concentrated at the retina in a diffraction spot (wavelengths of  $0.4 \mu\text{m}$  to  $1.4 \mu\text{m}$ ). The corneal irradiance or radiant exposure at the point of interest may be calculated using equations 8a and 8b of this appendix.

**E-3. Viewing the Reflected Beam.** *a. Specular Reflection.* Specular reflection requires a mirror-like surface. If the reflecting surface is flat, the characteristics of the reflected beam may be considered identical to those of the direct beam except that the range is the sum of the distances from the laser source to reflector and from reflector to the eye. If the surface is not flat, the reflected intensity arriving at the cornea is less and may be readily calculated for a uniformly curved surface, if the curvature is known. Discounting finely polished mirrors, reflecting surfaces will generally reflect only a fraction of the beam. The magnitude of the reflection is dependent

upon the specular reflectivity coefficient, and the angle of incidence. For normal (perpendicular) incidence, typical plate glass will reflect approximately 8 percent and transparent plastics will reflect approximately 6 percent of the incident beam, but at near-grazing incidence, nearly all of the incident radiant energy is reflected. This effect is shown graphically in figure E-1. The curves in figure E-1 show reflectance for light of polarization perpendicular ( $\perp$ ) to the plane of incidence and for light of polarization parallel ( $\parallel$ ) to the plane of incidence. Such a curve drawn for water would show 2 percent reflection at normal incidence and a polarizing angle at  $53^\circ$ . The practical significance of figure E-1 is shown in figure E-2 where a collimated laser beam is incident upon a plate glass window.

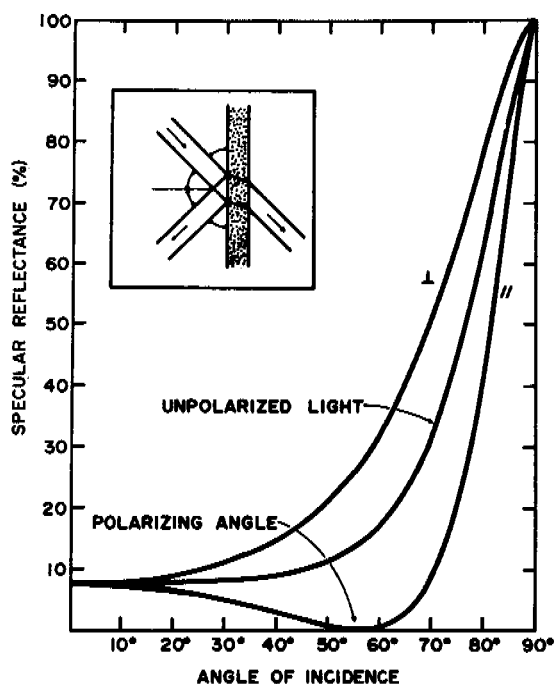

Figure E-1. Specular reflectance from both surfaces of plate glass having an index of refraction of 1.5.

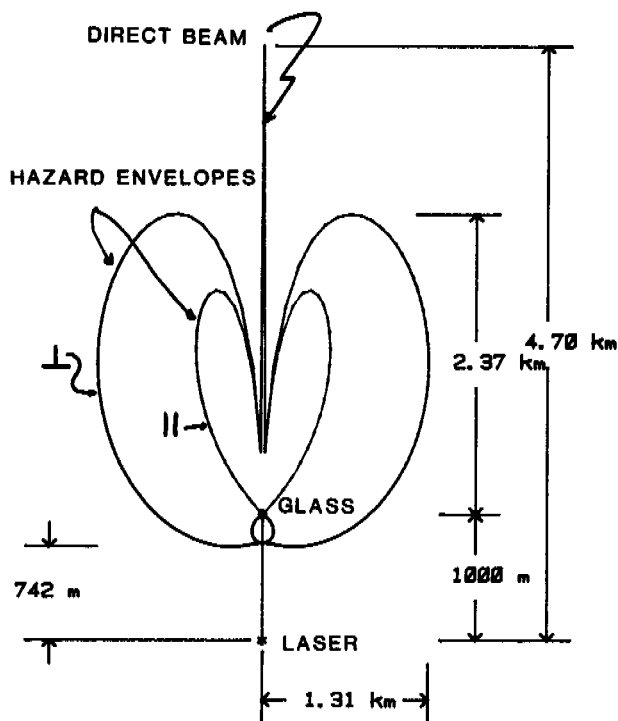

Figure E-2. Hazard envelopes created by a laser beam incident upon a vertically oriented flat ( $30 \text{ cm} \times 15 \text{ cm}$ ) glass surface.

*b. Diffuse reflection.* The reflection from a flat diffuse surface obeys Lambert's Law [see equation (5) below] which relates the energy or power per solid angle to the radiant energy or power at the surface (i.e., essentially the "inverse square law"). A maximum incident radiant exposure or irradiance for the

irradiation of a diffuse material may be calculated from table D-1. Such a maximum irradiance or radiant exposure would be the same regardless of the distance of the viewer or apparent size of the image, since the radiant exposure or irradiance at the retina remains the same. If the laser spot subtends an angle less than  $\alpha_{\min}$  [equation (3) below], the maximum allowable incident radiant exposure or reflected radiance may be greater than the value in D-1. In this case, the level of reflected light arriving at the eye may again be calculated by Lambert's Law. At wavelengths other than those within the retinal hazard region (0.4 to 1.4  $\mu\text{m}$ ) the concept of permissible surface radiances do not apply, and Lambert's Law is always utilized to determine the irradiance or radiant exposure at the point of interest for direct comparison with the applicable exposure limits in table C-1 or table C-3.

*c. Reflections from natural objects.* Although most targets encountered in a field situation are reasonably diffuse, some may behave as specular or semi-specular reflectors and shall be evaluated. Natural surfaces, which provide some form of specular reflections, generally have a small radius of curvature (e.g., water droplets, leaves) such that hazardous reflected levels exist only near the reflector. Still ponds and flat plate glass are the principal reflectors which could produce hazardous reflections at a distance. As a general rule, laser irradiances or radiant exposures which are safe to view by diffuse reflection will not create hazardous reflections from water droplets and natural foliage at viewing distances greater than 1 meter. Many glossy surfaces behave in a specular manner at grazing angles of incidence; however, the reflected beam will be very close to the beam axis of the initial beam.

**E-4. Other Factors.** *a. Atmospheric effects.* The effect of atmospheric attenuation may become a major factor in evaluating the radiant exposure or irradiance at distances greater than a few kilometers. This attenuation is the sum of three effects: Mie (or large particle) scattering, where the particle size is greater than the wavelength of the optical radiation, and is normally the greatest contributor in the visible and near-infrared; Rayleigh (or molecular) scattering, where particle size is much less than the wavelength, is reasonably constant for a given wavelength and is the greatest contributor in the ultraviolet; and absorption by gas molecules, which is normally relatively insignificant in comparison to scattering and may therefore be disregarded except in the infrared. Attenuation due to scattering is much more pronounced at shorter wavelengths; thus red light from a ruby laser is scattered far less than wavelengths in the blue end of the visible spectrum. A clean atmosphere may therefore be expected to be relatively

transparent to the ruby (694.3 nm) and neodymium-YAG (1064 nm) wavelengths. The atmospheric attenuation effect upon a nondiverging beam is expressed by equation (11) below. The scattering effect may theoretically attenuate a ruby laser beam by as little as 10 percent at 10 kilometers and 60 percent at 100 kilometers, but such an atmospheric quality is rarely achieved even in arid zones. The meteorological visibility, based upon the entire visible spectrum, may not be readily utilized in arriving at the attenuation coefficient at a given wavelength. Atmospheric turbulence creates scintillation resulting in localized "hot spots" within the beam. Scintillation creates the largest variation in beam irradiances when the change of air temperature with height is great. The situation is most characteristic in a desert atmosphere with few clouds and least characteristic in a day with heavy overcast. A variation of local irradiances within a beam after traversing a beam path in excess of one kilometer may typically be a factor of 10 or more. Thus, local beam irradiances may occasionally exist which are greater than would be expected if the beam experienced no turbulence.

*b. The effect of optical viewing instruments.*

(1) When viewing a bright object larger than a "point" source through a well designed optical instrument, the amount of light or near-infrared radiation reaching the retina is increased by the square of the magnifying power of the system. However, since there is a commensurate increase in the area of the retinal image, the retinal irradiance remains unchanged except for a slight reduction due to the loss or attenuation of light in the optical system [equation (14) below].

(2) If, however, the laser is viewed directly from within the beam, or by specular reflection, the parallel rays of the laser beam would behave as if they were coming from a point source and the retinal image thus formed may be diffraction-limited regardless of magnification by means of an optical viewing system. This means that the radiant power reaching the retina is increased by the square of the magnifying power of the optical system, except for light losses in the optical system, and that there would be a commensurate increase in the retinal irradiance [equation (12) below].

(3) There is a borderline condition close to the laser where a retinal image formed by viewing through an optical system may actually be larger than a diffraction-limited image; nevertheless, the parallel elements characteristic of a laser beam would behave as for a point source and a reduction of retinal irradiance should not be assumed.

**E-5. Calculations for Hazard Evaluation and Classification.** Calculations are not necessary for hazard

evaluation and classification in many applications; however, in range applications and other specialized uses where eye exposure is contemplated, several types of calculations permit the important quantitative study of potential hazards. Mathematical symbols used throughout are defined in paragraph E-6. Hazard classification and determination of exposure limits may require the use of equations in section III. Equations useful in estimating exposure at significant distances from the laser and optically aided viewing are presented in section IV. Figures E-3 through E-5 illustrate ocular viewing conditions.

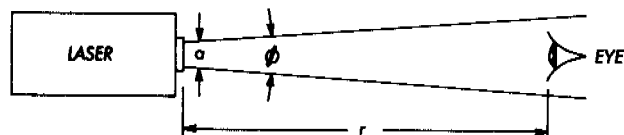

Figure E-3. Intra-beam viewing—direct beam (primary beam).

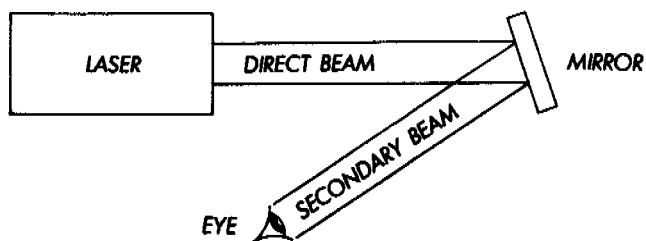

Figure E-4a. Intra-beam viewing—specularly reflected from flat surface (secondary beam).

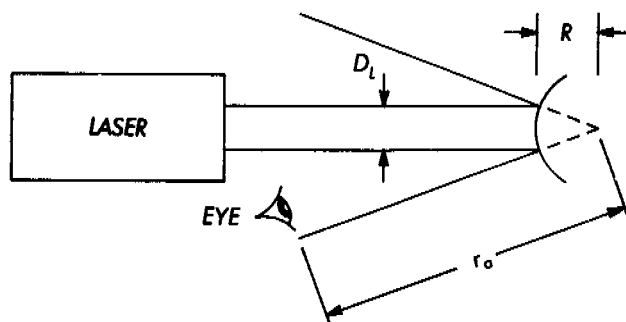

Figure E-4b. Intra-beam viewing—specularly reflected from curved surface (secondary beam).

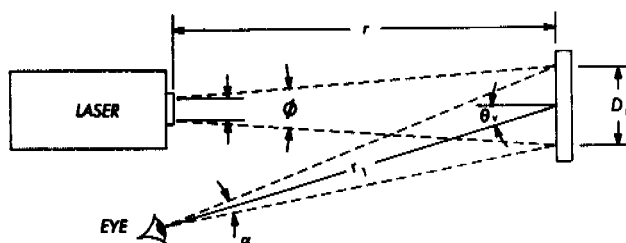

Figure E-5. Extended source viewing—normally a diffuse reflection.

## Section II. MATHEMATICAL SYMBOLS

### E-6. Definitions.

$a$	= Diameter of emergent laser beam (cm)	$E_o, H_o$	= Emergent beam radiant exposure ( $H_o$ ) or irradiance ( $E_o$ ) at zero range (units as for E, H)
$d$	= Diameter of measuring aperture (cm)	$f$	= Effective focal length of eye (1.7 cm)
$d_e$	= Diameter of the pupil of the eye (varies from approximately 0.2 to 0.7 cm)	$f(x)$	= Fraction of beam power or energy passing through an aperture of diameter, $d$
$d_{min}$	= Limiting object size of extended object (cm)	$F$	= Pulse repetition frequency (PRF), $s^{-1}$ or Hz
$D_e$	= Diameter of the exit pupil of an optical system (cm)	$G$	= Ratio of retinal irradiance or radiant exposure received by an optically aided eye to that received by unaided eyes
$D_L$	= Diameter of laser beam at range $r$ (cm)	$L$	= Radiance of an extended source ( $W \cdot cm^{-2} \cdot sr^{-1}$ )
$D_o$	= Diameter of objective of an optical system (cm)	$L_p$	= Integrated radiance of an extended source ( $J \cdot cm^{-2} \cdot sr^{-1}$ )
$e$	= Base of natural logarithms, 2.718	$n$	= Number of pulses in a train of pulses
$E, H$	= Radiant Exposure (H) or irradiance (E) at range $r$ , measured in $J \cdot cm^{-2}$ for pulsed lasers and $W \cdot cm^{-2}$ for CW lasers, respectively	NOHD	= Nominal ocular hazard distance
EL	= Exposure limit	NOHD*	= Nominal ocular hazard distance when optical aids are used
EEL	= Effective exposure limit	P	= Magnifying power of an optical system

Q	= Total radiant energy output of a pulsed laser, measured in J	T <sub>max</sub>	= Classification duration (i.e., a maximum duration of daily exposure inherent in the design of the laser device)
H <sub>i</sub>	= Individual Pulse Protection Standard	t	= Duration of single pulse(s)
r	= Range from the laser to some point downrange	α	= Viewing angle subtended by an extended source (in radians)
r <sub>1</sub>	= Range from the laser target to the viewer (cm)	α <sub>min</sub>	= Minimum angle subtended by a source for which extended source exposure limit applies (radians)
r <sub>1max</sub>	= Maximum range from the laser target to the viewer where extended source exposure limit applied (cm)	μ	= Atmospheric attenuation coefficient (cm <sup>-1</sup> ) at a particular wavelength
R	= Radius of curvature of a specular surface (cm)	φ	= Emergent beam divergence measured in radians
S	= Scan rate of a scanning laser (number of scans across the eye per second)	Φ	= Total radiant power (or radiant flux) output of a CW laser, or average radiant power of a repetitively pulsed laser, measured in watts
T	= Total exposure duration (in seconds) of a train of pulses	θ	= Angle of incidence
T <sub>1</sub>	= An exposure duration dependent correction factor. See figure C-7	φ <sub>p</sub>	= Peak radiant power
T <sub>i</sub>	= Integrated "on-time" of a train of pulses	ρ <sub>λ</sub>	= Spectral reflectance of a diffuse object at wavelength λ
		τ	= Transmittance of a filter
		θ <sub>s</sub>	= Maximum angular sweep of a scanning beam (radians)
		θ <sub>v</sub>	= Viewing angle, see figure E-5

**Section III. EXAMPLES OF DETERMINATION OF APPLICABLE EXPOSURE LIMIT AND LASER CLASSIFICATION**

**E-7. Determining the Exposure Limit for Intra-beam Viewing for Particular Exposure Durations.**

*a. Single-pulse laser exposure limits.* These are determined by reading values directly from the appropriate table or graph in appendix C, or they may be calculated.

**EXAMPLE 1. Single-Pulse-Visible Laser.**

Determine the exposure limit for a direct intrabeam exposure to a 694.3 nm ruby laser pulse having a duration of 8 × 10<sup>-4</sup> s (0.8 ms). The exposure limit for such a laser exposure is defined in table C-1.

Exposure Limit:

(1) 
$$H = 1.8t^{3/4} \text{ mJ} \cdot \text{cm}^{-2}$$

Exposure Limit:

$$\begin{aligned} H &= 1.8(8 \times 10^{-4})^{3/4} (10^{-3}) \text{ J} \cdot \text{cm}^{-2} \\ &= 1.8(4.75 \times 10^{-3})(10^{-3}) \text{ J} \cdot \text{cm}^{-2} \\ &= 8.6 \text{ } \mu\text{J} \cdot \text{cm}^{-2} \end{aligned}$$

**EXAMPLE 2. Single-Pulse, Near Infrared Laser.** Determine the exposure limit for intrabeam direct

viewing of a 1.064 μm (Nd:YAG) laser having a pulse duration of 8 × 10<sup>-4</sup> s. Since the direct beam exposure limit for this laser listed in table C-1 is five times that for the visible laser having the same exposure duration:

Exposure Limit:  
(2)

$$H = 9t^{3/4} \text{ mJ} \cdot \text{cm}^{-2} = 43 \text{ } \mu\text{J} \cdot \text{cm}^{-2}$$

*b. Repetitively pulsed laser exposure limit.* To determine the exposure limit applicable for an exposure to a repetitively pulsed laser, the wavelength, PRF, and duration of a single pulse and the duration of the complete exposure must be known. In each instance this process requires three steps.

**STEP 1.** The single-pulse limitation requires that the exposure shall not exceed the single-pulse protection standard for a total-on-time pulse (para C-5) for pulses greater than 10<sup>-5</sup> second and may not exceed this single-pulse exposure limit multiplied by the correction factor in figure C-5 for pulses less than 10<sup>-5</sup> seconds.

**STEP 2.** The average-power limitation requires the calculation of the average irradiance or total radiant exposure for the entire pulse train for

comparison with the exposure limit applicable for the duration of the entire exposure (para C-5b).

STEP 3. The results of STEPS 1 and 2 shall then be compared and the limitation which provides the lowest total exposure applied.

**EXAMPLE 3. Repetitively Pulsed Visible Laser—Very High PRF.**

Determine the direct intrabeam exposure limit of a 514.5 nm (Argon) laser for a 0.25 s total exposure T, operating at a PRF = 10 MHz and t = 10 ns (i.e.,  $10^{-8}$  s). Following b above, consider at least two criteria:

STEP 1. *Individual pulse limitation.*

First determine the reduced exposure limit for an individual pulse. For a PRF greater than 1 kHz, the reduction factor from figure C-5 is 0.06 for a 10 ns pulse.

Exposure Limit/Pulse:

$$H_i = 0.06 \times (5 \times 10^{-7} \text{ J}\cdot\text{cm}^{-2}) \\ = 3 \times 10^{-8} \text{ J}\cdot\text{cm}^{-2} = 30 \text{ nJ}\cdot\text{cm}^{-2}$$

On this basis the exposure limit for the total exposure is—

Exposure Limit/Train:

$$H = H_i \cdot F \cdot T \\ = (3 \times 10^{-8} \text{ J}\cdot\text{cm}^{-2}) (10^7 \text{ Hz}) (0.25 \text{ s}) \\ = 7.5 \times 10^{-2} \text{ J}\cdot\text{cm}^{-2} = 75 \text{ mJ}\cdot\text{cm}^{-2}$$

STEP 2. *Average radiant exposure limitation.*

For a single exposure of 0.25 s, the exposure limit is (from table C-1)—

Exposure Limit:  $H \leq 6.3 \times 10^{-4} \text{ J}\cdot\text{cm}^{-2} = 0.63 \text{ mJ}\cdot\text{cm}^{-2}$

STEP 3. *Conclusion.*

Since STEP 2 above is the limiting case (more restrictive), the correct exposure limit is—

Exposure Limit:

$$H = 6.3 \times 10^{-4} \text{ J}\cdot\text{cm}^{-2} \text{ in } 0.25 \text{ seconds}$$

$$\text{or } E_{(\text{avg})} = \frac{H}{T} = \frac{6.3 \times 10^{-4} \text{ J}\cdot\text{cm}^{-2}}{0.25 \text{ s}} = 2.5 \text{ mW}\cdot\text{cm}^{-2}$$

**EXAMPLE 4. Repetitively Pulsed, Near-Infrared Laser with Moderate PRF.**

Determine the intrabeam viewing exposure limit for a 905 nm (GaAs) laser which has t = 100 ns (i.e.,  $10^{-7}$  s) and PRF = 1 kHz. Since the 905 nm wavelength will not provide a natural aversion response as a visible wavelength laser would, assume a 10 s exposure duration T, for this particular laser application where eye and body movements limit the exposure duration. From figure C-5, the reduction factor for PRF = 1 kHz is 0.06 and from figure C-4 the wavelength correction factor is 2.57 at 905 nm.

STEP 1. *Individual pulse limitation.*

From table C-1, the exposure limit is—

Exposure Limit Pulse:

$$H_i = (2.5) (0.06) (5 \times 10^{-7} \text{ J}\cdot\text{cm}^{-2}) \\ = 7.7 \times 10^{-8} \text{ J}\cdot\text{cm}^{-2} = 75 \text{ nJ}\cdot\text{cm}^{-2}$$

and on this basis the exposure limit for the entire train would be—

Exposure Limit Train:

$$H \leq (10 \text{ s}) (10^3 \text{ Hz}) (7.7 \times 10^{-8} \text{ J}\cdot\text{cm}^{-2}) \\ = 7.7 \times 10^{-4} \text{ J}\cdot\text{cm}^{-2} = 0.75 \text{ mJ}\cdot\text{cm}^{-2}$$

STEP 2. *Average power limitation.*

From table C-1 the exposure limit is—

$$H_i = 1.8 C_A t^{3/4} \text{ mJ}\cdot\text{cm}^{-2}$$

$$C_A = 2.57 @ 905 \text{ nm}$$

$$t^{3/4} = 10^{3/4} = 5.62$$

$$H_i = (1.8)(2.57)(5.62) \text{ mJ}\cdot\text{cm}^{-2}$$

$$= 2.6 \times 10^{-2} \text{ J}\cdot\text{cm}^{-2} = 26 \text{ mJ}\cdot\text{cm}^{-2}$$

STEP 3. *Conclusion.*

Clearly the limitation in STEP 1 determines the exposure limit.

Exposure Limit/Train:  $H = 7.7 \times 10^{-4} \text{ J}\cdot\text{cm}^{-2}$

**EXAMPLE 5. Low PRF, Long Pulse, Repetitively Pulsed Visible Laser.**

Determine the exposure limit for a 632.8 nm (HeNe) laser where T = 0.25 s, t =  $10^{-3}$  s, and PRF = 100 Hz.

STEP 1. *Individual pulse limitation.*

Following paragraph C-5b, find the total on-time.  $T_i$  for the 0.25 s exposure is—

$$T_i = t \cdot \text{PRF} \cdot T$$

$$T_i = (10^{-3} \text{ s}) (100 \text{ Hz}) (0.25 \text{ s}) = 2.5 \times 10^{-2} \text{ s}$$

From table C-1, the exposure limit for the exposure time  $T_i$  is—

$$H = 1.8 t^{3/4} \text{ mJ}\cdot\text{cm}^{-2}$$

$$= 1.8 (2.5 \times 10^{-2} \text{ s})^{3/4} \text{ mJ}\cdot\text{cm}^{-2}$$

$$= 0.11 \text{ mJ}\cdot\text{cm}^{-2}$$

$$H_i = \frac{0.11 \text{ mJ}\cdot\text{cm}^{-2}}{25 \text{ pulses}} = 4.5 \text{ }\mu\text{J}\cdot\text{cm}^{-2}$$

now  $H_i \times \text{PRF} = \text{Average power limit}$

$$(4.5 \times 10^{-6}) (100) = 4.5 \times 10^{-4} \text{ W}\cdot\text{cm}^{-2}$$

$$= 0.45 \text{ mW}\cdot\text{cm}^{-2}$$

STEP 2. *Average power limitation.*

For a 0.25 s exposure, the exposure limit from table C-1 is —

$$H = 1.8 t^{3/4} \text{ mJ}\cdot\text{cm}^{-2} = 1.8 (0.25)^{3/4} \text{ mJ}\cdot\text{cm}^{-2} \\ = 0.64 \text{ mJ}\cdot\text{cm}^{-2}$$

For a 0.25 s exposure, this results in an average power exposure limit of—

$$0.64 \text{ mJ}\cdot\text{cm}^{-2} \div 0.25 \text{ s} = 2.55 \text{ mW}\cdot\text{cm}^{-2}$$

STEP 3. *Conclusion.*

STEP 1 defines the exposure limit in this case.

**EXAMPLE 6. One Pulse Group, Short-Pulse Laser.** Find the exposure limit of a Q-switched neodymium-YAG (Yttrium-Aluminum-Garnet) laser (1064 nm) which has an output of three, 20 ns pulses each separated by 100 ns. Since this is not a repetitively pulsed laser in the usual sense (i.e., having a continuous train of pulses lasting of the order of 0.25 s or more with the pulses being reasonably equally spaced),  $H_i$  should not be used and the following rule should be applied. Since the intrabeam exposure limit is a total radiant exposure of  $5 C_P \mu\text{J}\cdot\text{cm}^{-2}$  between  $10^{-9}$  and 50  $\mu\text{s}$  regardless of how fast the radiant energy is delivered this group of pulses should be considered as one pulse. The exposure limit per pulse is—

$$\frac{5 \times 10^{-6}}{3} = 1.7 \times 10^{-6} \text{ J}\cdot\text{cm}^{-2} = 1.7 \mu\text{J}\cdot\text{cm}^{-2}$$

**EXAMPLE 7. Series of Pulse Groups, Short Pulse Laser.**

Find the exposure limit for a doubled Nd YAG LASER (530 nm) used in a pulse-coded signal transmitter. The laser presents 100 words to transmit a message. Each word contains 10 laser pulses of 20 ns duration randomly spaced in 20 equally spaced time intervals of 20  $\mu\text{s}$  in duration. The words are transmitted every 1 ms.

STEP 1. Since the exposure time is less than 10 s, the alternate method for calculation of  $C_P$  may be used. Calculate  $C_P$  based on the total number of pulses,  $n$ .

$$n = (100)(10) = 1000$$

$$C_P = n^{-1/4} = 0.18$$

$$H = (5 \times 10^{-7})(0.18) = 90 \text{ nJ}\cdot\text{cm}^{-2}$$

STEP 2. Calculate standard for each group of pulses.

Consider one word as a pulse with a duration of  $t = (20)(20 \times 10^{-6} \text{ s}) = 400 \mu\text{s}$ . Since 100 words are transmitted, the total "on time" is  $100(400 \mu\text{s}) = 40 \text{ ms}$ .

$$H = 1.8(0.04)^{3/4} \text{ mJ}\cdot\text{cm}^{-2} = 0.16 \text{ mJ}\cdot\text{cm}^{-2}$$

Since 1000 pulses are transmitted, the exposure limit for each pulse is:

$$H = \frac{0.16 \text{ mJ}\cdot\text{cm}^{-2}}{1000} = 160 \text{ nJ}\cdot\text{cm}^{-2} \text{ per pulse}$$

STEP 3. *Conclusion.*

Since STEP 1 provides the most restrictive exposure limit, it should be used.

$$H = 90 \text{ nJ}\cdot\text{cm}^{-2} \text{ per pulse}$$

**EXAMPLE 8. Repetitively Pulsed Pulse Groups.**

Find the exposure limit for an Argon laser (514.5 nm) used in a pulse-code-modulated (pcm) communications link. The laser presents  $10^4$  "words" per second (i.e.,  $10^4$  pulse groups per second) and each word consists of five 20 ns pulses spaced at coded intervals such that each pulse group lasts no longer than 1  $\mu\text{s}$ . Using the approach of example 6, each pulse group is considered a single pulse and the exposure limit for each group is obtained using the PRF correction factor of 0.06 for a PRF of 10 kHz.

STEP 1. *Individual pulse (group) limitation exposure limit (pulse group).*

$$\begin{aligned} H &= (5 \times 10^{-7} \text{ J}\cdot\text{cm}^{-2})(0.06) \\ &= 3 \times 10^{-8} \text{ J}\cdot\text{cm}^{-2} = 30 \text{ nJ}\cdot\text{cm}^{-2} \end{aligned}$$

The average exposure limit using this STEP is—

$$\begin{aligned} E_{\text{avg}} &= H \times \text{PRF} = (3 \times 10^{-8} \text{ J}\cdot\text{cm}^{-2})(10^4 \\ &\text{Hz}) = 0.3 \text{ mW}\cdot\text{cm}^{-2} \end{aligned}$$

STEP 2. *Average power limitation.*

For a 0.25 s exposure the exposure limit from table C-1 for a nonmodulated laser is—

Exposure Limit:

$$E = 2.5 \times 10^{-3} \text{ W}\cdot\text{cm}^{-2} = 2.5 \text{ mW}\cdot\text{cm}^{-2}$$

STEP 3. *Conclusion.*

Since STEP 1 is more restrictive, it is applicable.

Exposure Limit (average power)

$$= 3 \times 10^{-4} \text{ W}\cdot\text{cm}^{-2} = 0.3 \text{ mW}\cdot\text{cm}^{-2}$$

**E-8. Determining When to use the Extended Source Exposure Limits.** The intrabeam exposure limits are used in all situations of intrabeam viewing of the direct beam or specularly reflected beam, except for close viewing of laser diodes or diode-arrays. The intrabeam exposure limits are also used when viewing an extended source at a distance greater than  $r_{1\text{max}}$ .

*a. Extended source exposure limits application.*

The extended source exposure limits are applied only in the spectral region of 400 to 1400 nm where the source size is significantly larger than a "point" and where the corresponding retinal image in the viewer's eye is definitely not a "minimal spot." Diffuse reflections are extended sources at close viewing distances; therefore, depending upon the laser and environmental considerations, the extended source exposure limits may have to be considered. Classes 1 and 2 lasers are not capable of producing hazardous diffuse reflections and only the intrabeam exposure limits are applied (except for intrabeam viewing of semiconductor-diode laser arrays). Class 3 (visible and near-infrared) lasers are not capable of producing hazardous diffuse reflections unless focused, and intrabeam exposure limits would normally be used (except for laser diode arrays). Some Class 4 (visible and NIR) lasers are capable of producing hazardous diffuse reflections at close viewing distances.

b. *The brightness units.* The radiometric quantities of radiance  $\text{W}\cdot\text{cm}^{-2}\cdot\text{sr}^{-1}$  and integrated radiance  $\text{J}\cdot\text{cm}^{-2}\cdot\text{sr}^{-1}$  are used for extended sources since these quantities, which describe the source directly, determine the irradiance distribution of the retinal image due to an extended source. The radiance of a diffuse reflection is directly related to the incident beam irradiance and the latter quantity may be more easily applied in practical hazard evaluation. Table D-1 presents the incident beam radiant exposures corresponding to integrated radiance exposure limits.

c. *Applying the limiting angle ( $\alpha_{\min}$ ).* This angle is used to determine if viewing distances ( $r_1$ ) in a given situation may be sufficiently close to apply extended source criteria. Figure E-5 shows the relation of  $r_1$ ,  $D_L$ , and  $\alpha_{\min}$ .

$$(3) \quad \alpha = \frac{D_L \cos \theta_v}{r_1}; \quad \alpha_{\min} = \frac{D_L \cos \theta_v}{r_{1\max}}$$

$$\text{for } \theta_v \leq 0.37 \text{ radian } (21^\circ)$$

**EXAMPLE 9.** *Finding the Maximum Distance Where the Extended Source Protection Standard Applies.*

Find the maximum distance  $r_{1\max}$  for a visible laser having an emergent beam diameter  $a = 1$  cm, a beam divergence  $\phi = 10^{-4}$  radian, and a pulse duration of 20  $\mu\text{s}$ . A diffuse matte target is placed 100 cm from the beam exit of the laser (i.e., the target distance  $r = 100$  cm). The relation of  $D_L$  to the emergent beam divergence and diameter is—

$$(4) \quad D_L = a + r\phi$$

At short target distances  $D_L$  is clearly the same as  $a$  or 1 cm and using equation 3 and finding  $\alpha_{\min}$  from figure C-3—

$$r_{1\max} = \frac{a}{\alpha_{\max}} = \frac{1 \text{ cm}}{(1.6 \times 10^{-3} \text{ rad})} = 625 \text{ cm}$$

Therefore, at viewing distances less than 625 cm from the target, the applicable exposure limit from table C-2 is  $2.8 \times 10^{-1} \text{ J}\cdot\text{cm}^{-2}\cdot\text{sr}^{-1}$  and for greater distances the applicable exposure limit from table C-1 is  $5 \times 10^{-7} \text{ J}\cdot\text{cm}^{-2}$ . This example illustrates that for most pulsed lasers the extended source exposure limits are applicable in indoor areas such as laboratories. Exceptions would be focused beam diffuse reflections such as those occurring in micro-drilling. For visible CW lasers where the exposure time could be 0.25 s or greater and where  $a$  is often only 0.1 to 0.2 cm,  $\alpha_{\min}$  is sufficiently great (10–24 mrad) that the maximum  $r_1$  to apply these protection standards would be only a few cm and the intrabeam exposure limits would be more relevant. For  $a = 0.1$  cm, and  $\alpha_{\min} = 24$  mrad,  $r_{1\max} = 4.2$  cm.

**EXAMPLE 10.** *Extended Source Exposure Limits for Diffuse Reflections Expressed as Incident Beam Irradiance or Radiant Exposure.*

In most cases it is simplest to consider the incident beam irradiance or radiant exposure as being capable or not capable of producing a hazardous diffuse reflection rather than have to deal with less familiar radiometric quantities such as radiance. Consider the laser defined in example 8. Since the extended source exposure limit is expressed as an integrated radiance we need to know the beam radiant exposure at the target which produces this integrated radiance. The relation is—

$$(5) \quad L_p = \frac{H_p \lambda}{\pi} \quad \text{or} \quad H = \frac{\pi L_p}{\rho_\lambda}$$

Hence the exposure limit expressed for a 100 percent reflectance white diffuse target is—

$$H = \frac{(3.14)(2.8 \times 10^{-1} \text{ J}\cdot\text{cm}^{-2} \text{ sr}^{-1})}{1.0} \\ = 0.88 \text{ J}\cdot\text{cm}^{-2}$$

#### NOTE

Equation 5 is strictly true only for a theoretically perfect Lambertian surface; however, unless a surface has a highly glossy sheen, it may be considered sufficiently “diffuse” to apply this equation and the diffuse surface exposure limits. The above result could have been obtained by interpolating the values in column 4 of table D-1 between  $10^{-5}$  s and  $10^{-4}$  s.

**EXAMPLE 11.** *Spectral Corrections for Near Infrared Laser Protection Standards.*

A gallium-arsenide laser operating at room temperature has a peak wavelength at 904 nm. What is the exposure limit for a single pulse of 200 ns duration? Using figure C-4, the spectral correction factor is 2.57. Using table C-1, the exposure limit for direct viewing of the source is  $(2.57)(5 \times 10^{-7} \text{ J}\cdot\text{cm}^{-2}) = 1.3 \times 10^{-6} \text{ J}\cdot\text{cm}^{-2}$  for a single pulse. Similarly, the extended source exposure limit for sources subtending an angle greater than 3.3 mrad (from table C-2 for 200 ns) is  $(2.57)(5.8 \times 10^{-2} \text{ J}\cdot\text{cm}^{-2}\cdot\text{sr}^{-1}) = 1.5 \times 10^{-1} \text{ J}\cdot\text{cm}^{-2}\cdot\text{sr}^{-1}$ .

#### NOTE

Unlike gas or solid-state lasers, this semiconductor laser could be an extended source at close viewing range within the beam if the line source was magnified by a projector lens.

**E-9. Central Beam Irradiance or Radiant Exposure.** Often the beam irradiance or radiant exposure is not provided in a laser's specification. However, if the laser is single-mode and has a Gaussian beam profile the central beam values may be obtained from the beam diameter specified at 1/e points and the beam radiant power or energy. The relations are—

$$(6) \quad H_0 = \frac{4Q}{\pi a^2} = \frac{1.27Q}{a^2}; \quad E_0 = \frac{4\Phi}{\pi a^2} = \frac{1.27\Phi}{a^2}$$

However, the exposure limits may be specified as averaged over a 1-mm or 7-mm aperture. In which case, the calculated values of  $E_0$  or  $H_0$  from equation 6 may not be relevant. To obtain the maximum beam irradiance or radiant exposure averaged over a 7-mm aperture in the center of the beam, the following relations may be used:

$$(7a \ \& \ 7b) \quad \begin{aligned} E_0 &= 2.6 \ \Phi [1 - e^{-1/2 a^2}] \\ H_0 &= 2.6 \ Q [1 - e^{-1/2 a^2}] \end{aligned}$$

**E-10. Laser Classification.**

**EXAMPLE 12. Q-Switched Doubled Neodymium-YAG Laser.**

Classify a Q-switched *doubled* neodymium-YAG laser (532 nm) having an output peak power specified by the manufacturer as 20 MW, a pulse duration of 25 ns, and a laser rod diameter of 5/8 inch. The output energy is—

$$\begin{aligned} Q &= \Phi_p t = (2 \times 10^7 \text{ W})(2.5 \times 10^{-8} \text{ s}) \\ &= 0.5 \text{ J} \end{aligned}$$

Since the emergent beam diameter is not specified, it is only possible to estimate  $H_0$ . The value of  $a$  is clearly less than (5/8)(2.54) = 1.6 cm. Hence,  $H_0$  can be no less than—

$$H_0 = \frac{(1.27)(0.51\text{J})}{(1.6 \text{ cm})^2} = 0.25 \text{ J}\cdot\text{cm}^{-2}$$

Since  $H_0$  is well above the permissible radiant exposure incident upon a diffuse surface for  $p = 100$  percent (which must be a value between 0.068 and 0.15  $\text{J}\cdot\text{cm}^{-2}$  from column 4, table D-1), the device is classified as a Class 4 laser (app D).

**EXAMPLE 13. Rhodamine 6G Dye Laser.**

Classify a Rhodamine 6G Dye Laser that has a peak output at a wavelength of 590 nm. The energy output is 10 mJ in a 5-mm diameter beam for a duration 1  $\mu\text{s}$ . Since the emergent beam radiant exposure is 0.051  $\text{J}\cdot\text{cm}^{-2}$  which is less than 0.31  $\text{J}\cdot\text{cm}^{-2}$  (in colm

4, table D-1) a diffuse reflection hazard does not exist; and since 0.051  $\text{J}\cdot\text{cm}^{-2}$  is greater than  $5 \times 10^{-7} \text{ J}\cdot\text{cm}^{-2}$ , the laser is a Class 3 laser.

**EXAMPLE 14. Tunable Laser.**

Classify a tunable laser which could emit between 0.7 and 2  $\mu\text{m}$  at an output of 10 mJ in a 5-mm diameter beam for a duration of 1  $\mu\text{s}$ ; the device has been altered to lase only at a wavelength of 750 nm. From figure C-4, the wavelength correction factor is 1.5 and the applicable exposure limits used in example 13 are increased by this factor which still defines the laser as a Class 3 device.

**EXAMPLE 15. 1-Watt Argon Laser.**

A 1-watt Argon laser operating at 514.5 nm is to be used in a communications link. Determine under what conditions the emergent beam would not be considered a skin hazard. Then determine what hazard classification would apply. Since the total output power is greater than 0.5 W, the beam would have to be sufficiently large to reduce the irradiance to 0.2  $\text{W}\cdot\text{cm}^{-2}$  or less (table C-3).

$$E_0 = \frac{4\Phi}{a^2} = 0.2 \text{ W} = \frac{(4)(0.5)}{a^2}$$

$$a = \sqrt{\frac{(4)(0.5)}{(\pi)(0.2)}} = 1.8 \text{ cm}$$

Therefore, the beam diameter must be greater than 1.8 cm to preclude a skin hazard problem. The laser could fall into one of two classifications: Class 4 if more than 0.5 W exited from the laser system as an unenclosed beam; or Class 3 laser if after passing through beam forming optics the total optical power in the beam is less than 0.5 W.

**E-11. Beam Diameter and Beam Divergence.** Often the beam diameter or divergence is specified at 1/e<sup>2</sup> points rather than 1/e points so that equation 6 would calculate average values rather than the central beam values. In this case, divide the specified values of beam diameter or divergence by  $\sqrt{2}$  to obtain the 1/e values. Calculate the beam diameter from a measured fraction through an aperture for a Gaussian beam using the following relation:

$$(8a) \quad a = \sqrt{\frac{-d^2}{\ln[1 - f(x)]}}$$

At a distance from the laser, the beam is no longer Gaussian but may be approximated by a Gaussian shape; therefore, the following relation may be used:

$$(8b) \quad D_L = \sqrt{\frac{-d^2}{\ln[1 - f(x)]}}$$



One way to calculate beam divergence is to compare the beam diameter at a distance to the initial beam diameter.

$$(9) \quad \phi = \frac{D_L - a}{r} \quad \text{for small } \phi$$

**EXAMPLE 16. Central Beam Irradiance.**

From a Gaussian shaped beam, calculate the maximum central beam irradiance and the central beam irradiance averaged over a 7-mm aperture from a laser with a 5-mW output and an 8-mm beam diameter.

a. Maximum beam irradiance.

$$E_0 = \frac{1.27\Phi}{a^2} = \frac{1.27(5 \times 10^{-3} \text{ W})}{(0.8)^2}$$

$$= 10 \text{ mW}\cdot\text{cm}^{-2}$$

b. Maximum beam irradiance averaged over 7 mm.

$$E_0 = 2.6(5 \times 10^{-3} \text{ W}) \left[ 1 - e^{-1/2 (0.8)^2} \right]$$

$$= 7 \text{ mW}\cdot\text{cm}^{-2}$$

**EXAMPLE 17. Finding the Beam Diameter.**

a. Find the beam diameter to be used in calculations in hazard analysis. A laser beam diameter is specified as being 3 mm in diameter as measured at  $1/e^2$  of peak-irradiance points. The beam is further specified to be single-mode and Gaussian. Since the beam is Gaussian, we may use the relation that the beam diameter measured at  $1/e^2$  points is greater by a factor of  $\sqrt{2} = 1.41$ , hence—

$$a = \frac{0.3 \text{ cm}}{\sqrt{2}} = 0.21 \text{ cm}$$

b. From a Gaussian shaped beam, find the approximate beam diameter of a Gaussian laser beam having a total output power of 5 mW and a measured throughput power of 1 mW passing through a 7-mm aperture.

$$a = \sqrt{\frac{-(0.7)^2}{\ln(1 - 0.2)}} = 1.5 \text{ cm}$$

**EXAMPLE 18. Finding the Portion of a Beam Which Will Pass Through an Aperture.**

Find the maximum percentage of total power of a 3 mW HeNe laser which will pass through a 7-mm aperture if the beam diameter specified at  $1/e^2$  points

is 1.6 cm. The fraction of the total beam which passes through an aperture of diameter  $d = 7 \text{ mm}$  is—

$$(10) \quad f(x) = 1 - e^{-d^2/a^2}$$

as shown in figure E-6, where  $a =$  beam diameter.

The beam diameter at  $1/e = 1.6/\sqrt{2}$

$$= 1.1 \text{ cm}$$

$$f(x) = 1 - e^{-0.49/(1.1)^2} = 0.33$$

$$= 1 \text{ mW}$$

**EXAMPLE 19. 632.8 nm Visible Laser (HeNe).**

Classify a 632.8 nm visible laser (HeNe) used as a remote control switch. The laser is electronically pulsed with a 1-mW peak power output, a pulse duration of 0.1 s (hence an energy of  $10^{-4} \text{ J}\cdot\text{pulse}^{-1}$ ), and a beam diameter of one cm. The recycle time of the laser is 5 s (maximum PRF = 0.2 Hz). Since the device is pulsed with an exposure duration of 0.1 s, the applicable exposure limit for intrabeam viewing from figure C-1 is  $3.2 \times 10^{-3} \text{ W}\cdot\text{cm}^{-2}$  or  $3.2 \times 10^{-4} \text{ J}\cdot\text{cm}^{-2}$ . Using equation 6, the emergent beam radiant exposure per pulse is  $1.27 \times 10^{-4} \text{ J}\cdot\text{cm}^{-2}$  which is less than half the exposure limit. In the absence of biologic data and exposure limits for exposures repeated at PRFs less than 1 Hz, consider the exposures linearly additive. Following this rule, at least two exposures are possible after considering all three aspects in a hazard evaluation (chap 3, sec I). The prudent approach is to apply a WARNING label to the device with the words DO NOT STARE CONTINUOUSLY INTO LASER BEAM.

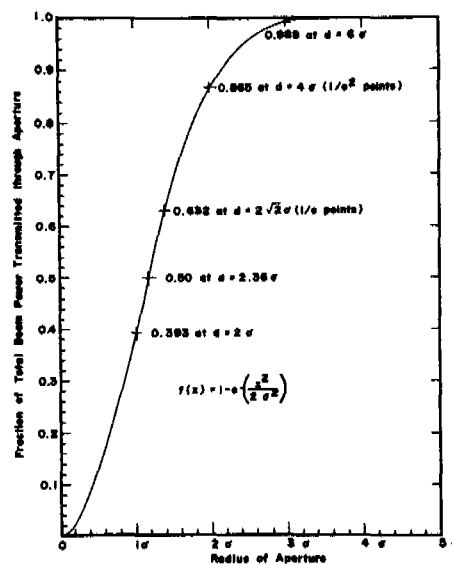

Figure E-6. Fraction of a Gaussian laser beam passing through a circular aperture.

Section IV. EQUATIONS AND EXAMPLES USEFUL IN EVALUATION OF VARIOUS LASER APPLICATIONS

**E-12. Beam Irradiance or Radiant Exposure.** Beam irradiance (E) or radiant exposure (H) for nondiverging beam at range, r, which is attenuated by the atmosphere is—

$$(11) \quad H = H_0 e^{-\mu r}, \quad E = E_0 e^{-\mu r}$$

**NOTE**

The attenuation coefficient  $\mu$  varies from  $10^{-4}$  per cm in thick fog to  $10^{-7}$  in air of very good visibility. The Rayleigh scattering coefficient at 6934 nm is  $4.8 \times 10^{-8} \text{ cm}^{-1}$ , and  $1.8 \times 10^{-7} \text{ cm}^{-1}$  at 500 nm. The effect of aerosols in even the cleanest atmospheres usually raises  $\mu$  at 6934 nm to at least  $5 \times 10^{-7} \text{ cm}^{-1}$ .

**E-13. Average Irradiance.** Average irradiance at range, r, (direct circular beam) is the total power in the beam at that range divided by the area of the beam at that range; and likewise the radiant exposure in a nonturbulent medium is the total energy in the beam at that range divided by the total area.

(12a & 12b)

$$E = \frac{\Phi e^{-\mu r}}{\pi/4(a + r\phi)^2} = \frac{1.27 \Phi e^{-\mu r}}{(a + r\phi)^2}$$

$$H = \frac{Q e^{-\mu r}}{\pi/4(a + r\phi)^2} = \frac{1.27 Q e^{-\mu r}}{(a + r\phi)^2}$$

**NOTE**

Accurate only for small  $\phi$  (i.e., accuracy better than 1 percent for angles below 0.17 radian ( $10^\circ$ ) and better than 5 percent for angles less than 0.37 radian ( $21^\circ$ )).

**NOTE**

For a Gaussian beam the maximum irradiance at the beam axis is calculated using equation 6, if a and  $\phi$  are defined at the 1/e points of maximum irradiance.

**EXAMPLE 20.**

To find the radiant exposure at 1 km ( $10^5 \text{ cm}$ ) of a 0.1 J ruby laser which has a beam divergence of 1 milliradian ( $10^{-3}$  radian) and an emergent beam diameter of 0.7 cm:

(use  $\mu = 10^{-7} \text{ cm}^{-1}$ )

$$H = \frac{1.27(0.1)e^{-(0.01)}}{[0.7 + (10^5)(10^{-3})]^2} = \frac{(1.27)(0.1)(0.99)}{(0.7 + 100)^2}$$

$$= 1.24 \times 10^{-5} \text{ J}\cdot\text{cm}^{-2} = 12.4 \mu\text{J}\cdot\text{cm}^{-2}$$

E-10

**E-14. Minimum Beam Diameter.** Minimum beam diameter at range r—

$$(13) \quad D_L = a + \phi r, \text{ for small } \phi$$

**EXAMPLE 21.**

Find the diameter of a laser beam at 1 kilometer where the emergent beam diameter is 10 cm and the beam divergence is 0.1 milliradian:

$$D_L = 10 \text{ cm} + (10^{-4} \text{ radian})(10^5 \text{ cm}) = 10 + 10 = 20 \text{ cm}$$

**E-15. Nominal Ocular Hazard Distance.** The NOHD with atmospheric attenuation may not be calculated directly. Therefore, the atmospheric term may be left out of the equation temporarily yielding a value of NOHD in vacuum [NOHD(v)]:

(14a & 14b)

$$\left. \begin{aligned} \text{NOHD}(v) &= \left(\frac{1}{\phi}\right) \left(\sqrt{\frac{1.27\Phi}{EL}} - a\right) \\ \text{NOHD}(v) &= \left(\frac{1}{\phi}\right) \left(\sqrt{\frac{1.27Q}{EL}} - a\right) \end{aligned} \right\} \text{without atmospheric attenuation}$$

Once the unattenuated beam is calculated, the value may be corrected for atmospheric attenuation ( $\mu = 5 \times 10^{-7} \text{ cm}^{-1}$ ) by finding the corresponding NOHD given in table E-1.

**EXAMPLE 22. Calculating Nominal Ocular Hazard Distance.**

From a Q-switched ruby laser with an exit beam diameter of 1.0 cm, an output energy of 50 mJ, and a beam divergence, calculate the NOHD as follows:

$$\text{NOHD}(v) = \left(\frac{1}{0.5 \times 10^{-3} \text{ rad}}\right) \left\{ \sqrt{\frac{1.27(0.05 \text{ J})}{5 \times 10^{-7} \text{ J}\cdot\text{cm}^{-2}}} - 1.0 \text{ cm} \right\}$$

$$= 7.1 \text{ km in vacuum}$$

$$\text{NOHD} = 6.1 \text{ km } (\mu = 5 \times 10^{-7} \text{ cm}^{-1})$$

**E-16. Reflected Irradiance or Radiant Exposure.** Reflected irradiance or radiant exposure for diffuse reflector: (for  $r \gg D_L$ )

(15a & 15b)

$$E = \frac{\Phi P_\lambda \cos \theta v}{\pi r_1^2} \quad H = \frac{Q \cos \theta v}{\pi r_1^2}$$

**EXAMPLE 23.**

Find the maximum reflected radiant exposure from a diffuse target of reflectance 0.6 which would return a distance of 10 meters to the operator of a 0.1 J laser:

$$(\cos \theta_v = 1)$$

$$H = \frac{(0.1\text{J})(0.6)}{(3.14)(10^3 \text{ cm})^2} = 19.1 \text{ nJ}\cdot\text{cm}^{-2}$$

**EXAMPLE 24.**

Find the hazardous intrabeam viewing distance (assume a 10 s exposure) for looking at a diffuse target having reflectivity  $p = 0.9$  from a laboratory argon laser with  $\Phi = 2 \text{ W}$  and  $a = 2 \text{ mm}$ . Since the emergent beam irradiance is more than  $6.3 \text{ W}\cdot\text{cm}^{-2}$  for a 10-second exposure we conclude that  $r_{1(\text{hazard})}$  must be greater than  $d_{\min}/\alpha$ . Hence (the 10 s exposure limit is  $1 \times 10^{-3} \text{ W}\cdot\text{cm}^{-2}$ ) ( $\cos\theta_v = 1$ )—

$$r_{1(\text{hazard})} = \frac{\phi p \lambda}{\pi E} = \frac{(2)(0.9)}{(\pi)(10^{-3})} = 24 \text{ cm}$$

**E-17. Viewing Aided by an Optical System.** The optical gain ( $G$ ) is defined as the ratio  $G$  of radiant exposure or irradiance at the retina to that when viewing by the unaided eye:

*a.* For intrabeam viewing of the primary beam and specular reflections of the primary beam where  $D_L > D_o$  (or a diffuse laser spot is unresolved by the eye and optical system) and the laser operates within the wavelength range of 400–1400 nm:

(16a &amp; 16b)

$$G = 2.04 D_o^2 \quad \text{for } 0.7 \text{ cm} \leq D_e$$

$$G = \frac{D_o^2}{D_e^2} = p^2 \quad \text{for } 0.7 \text{ cm} \geq D_e$$

**EXAMPLE 25. Finding the Extended NOHD (NOHD\*) When Optical Aids Are Used.**

Calculate the NOHD\* from a laser beam similar to that in Example 22 when the laser is viewed through  $7 \times 50$  binoculars.

STEP 1. Calculate the gain factor,  $G$ .Since  $P = D_o/D_e$ 

$$D_e = \frac{50}{7} = 7.14 \text{ mm}$$

From paragraph E-17a,  $G = \frac{D_o^2}{D_e^2} = p^2 = 49$

STEP 2. Insert the gain factor into equation 14 for NOHD.

(17a &amp; 17b)

$$\text{NOHD}^*(v) = 1/\phi \left\{ \sqrt{\frac{1.27\Phi G}{EL}} - a \right\}$$

$$\text{NOHD}^*(v) = 1/\phi \left\{ \sqrt{\frac{1.27QG}{EL}} - a \right\}$$

STEP 3. Calculate NOHD\*.

$$\text{NOHD}(v) = \frac{1}{(5 \times 10^{-4})} \left\{ \sqrt{\frac{1.27(0.05)49}{5 \times 10^{-7}}} - 1.0 \right\} = 50 \text{ km}$$

From table E-1, NOHD\* = 26 km

*b.* As an alternate method for calculating the corneal irradiance or radiant exposure averaged over a 7-mm pupillary diameter when optical aids are used, the following relations may be used:

(18a-18d)

$$\left. \begin{aligned} E_o &= 2.6\Phi \left[ 1 - e^{-D_o^2/D_L^2} \right] e^{-\mu r} \\ H_o &= 2.6Q \left[ 1 - e^{-D_o^2/D_L^2} \right] e^{-\mu r} \end{aligned} \right\} D_e \leq 7 \text{ mm}$$

$$\left. \begin{aligned} E_o &= \frac{1.27\Phi}{D_e^2} \left[ 1 - e^{-D_o^2/D_L^2} \right] e^{-\mu r} \\ H_o &= \frac{1.27Q}{D_e^2} \left[ 1 - e^{-D_o^2/D_L^2} \right] e^{-\mu r} \end{aligned} \right\} \begin{array}{l} D_e > 7 \text{ mm} \\ \text{and} \\ D_L > D_o \end{array}$$

**NOTE**When  $D_L < D_o$  use equations 18a and 18b.

*c.* For indirect viewing of a diffuse reflection or viewing extended objects only (i.e., object subtends angle greater than 0.6 milliradian when magnified)—

(19a &amp; 19b)

$$G = \frac{D_o^2}{p^2(0.7)^2} \leq 1 \quad \text{for } 7 \text{ cm} \geq D_e$$

and

$$G = \frac{D_o^2}{p^2 D_e^2} = 1 \quad \text{for } 0.7 \text{ cm} \leq D_e$$

**NOTE**

The ratio  $G$  is affected by the optical transmission  $\tau$  of the instrument, but this is normally not known. If the transmission is

Table E-1

Atmospherically corrected values of NOHD when the NOHD, with or without optics in vacuum, is known [NOHD(v)]

NOHD(v)	NOHD	NOHD(v)	NOHD	NOHD(v)	NOHD	NOHD(v)	NOHD	NOHD(v)	NOHD	NOHD(v)	NOHD
0.10	0.10	4.80	4.31	9.50	7.81	52.00	26.70	99.00	38.10	560.00	78.60
0.20	0.20	4.90	4.39	9.60	7.88	53.00	27.00	100.00	38.30	570.00	79.00
0.30	0.30	5.00	4.47	9.70	7.95	54.00	27.30	110.00	40.20	580.00	79.50
0.40	0.40	5.10	4.55	9.80	8.02	55.00	27.60	120.00	42.00	590.00	79.90
0.50	0.49	5.20	4.63	9.90	8.09	56.00	27.90	130.00	43.70	600.00	80.40
0.60	0.59	5.30	4.71	10.00	8.20	57.00	28.20	140.00	45.20	610.00	80.80
0.70	0.69	5.40	4.79	11.00	8.80	58.00	28.50	150.00	46.70	620.00	81.30
0.80	0.78	5.50	4.87	12.00	9.50	59.00	28.80	160.00	48.10	630.00	81.70
0.90	0.88	5.60	4.95	13.00	10.10	60.00	29.00	170.00	49.40	640.00	82.10
1.00	0.98	5.70	5.03	14.00	10.70	61.00	29.30	180.00	50.70	650.00	82.50
1.10	1.07	5.80	5.11	15.00	11.30	62.00	29.60	190.00	51.90	660.00	83.00
1.20	1.17	5.90	5.18	16.00	11.90	63.00	29.90	200.00	53.10	670.00	83.40
1.30	1.26	6.00	5.26	17.00	12.50	64.00	30.10	210.00	54.20	680.00	83.80
1.40	1.35	6.10	5.34	18.00	13.00	65.00	30.40	220.00	55.30	690.00	84.20
1.50	1.45	6.20	5.41	19.00	13.50	66.00	30.70	230.00	56.30	700.00	84.60
1.60	1.54	6.30	5.49	20.00	14.10	67.00	30.90	240.00	57.30	710.00	84.90
1.70	1.63	6.40	5.57	21.00	14.60	68.00	31.20	250.00	58.30	720.00	85.30
1.80	1.72	6.50	5.64	22.00	15.10	69.00	31.40	260.00	59.20	730.00	85.70
1.90	1.82	6.60	5.72	23.00	15.60	70.00	31.70	270.00	60.10	740.00	86.10
2.00	1.91	6.70	5.80	24.00	16.10	71.00	31.90	280.00	61.00	750.00	86.40
2.10	2.00	6.80	5.87	25.00	16.50	72.00	32.20	290.00	61.80	760.00	86.80
2.20	2.09	6.90	5.95	26.00	17.00	73.00	32.40	300.00	62.60	770.00	87.10
2.30	2.18	7.00	6.02	27.00	17.50	74.00	32.70	310.00	63.50	780.00	87.50
2.40	2.27	7.10	6.10	28.00	17.90	75.00	32.90	320.00	64.20	790.00	87.90
2.50	2.36	7.20	6.17	29.00	18.30	76.00	33.20	330.00	65.00	800.00	88.20
2.60	2.45	7.30	6.24	30.00	18.80	77.00	33.40	340.00	65.70	810.00	88.50
2.70	2.53	7.40	6.32	31.00	19.20	78.00	33.60	350.00	66.50	820.00	88.90
2.80	2.62	7.50	6.39	32.00	19.60	79.00	33.90	360.00	67.20	830.00	89.20
2.90	2.71	7.60	6.47	33.00	20.00	80.00	34.10	370.00	67.80	840.00	89.50
3.00	2.80	7.70	6.54	34.00	20.40	81.00	34.30	380.00	68.50	850.00	89.90
3.10	2.88	7.80	6.61	35.00	20.80	82.00	34.60	390.00	69.20	860.00	90.20
3.20	2.97	7.90	6.68	36.00	21.20	83.00	34.80	400.00	69.80	870.00	90.50
3.30	3.06	8.00	6.76	37.00	21.60	84.00	35.00	410.00	70.50	880.00	90.80
3.40	3.14	8.10	6.83	38.00	22.00	85.00	35.20	420.00	71.10	890.00	91.10
3.50	3.23	8.20	6.90	39.00	22.30	86.00	35.40	430.00	71.70	900.00	91.50
3.60	3.31	8.30	6.97	40.00	22.70	87.00	35.70	440.00	72.30	910.00	91.80
3.70	3.40	8.40	7.04	41.00	23.00	88.00	35.90	450.00	72.80	920.00	92.10
3.80	3.48	8.50	7.11	42.00	23.40	89.00	36.10	460.00	73.40	930.00	92.40
3.90	3.57	8.60	7.19	43.00	23.70	90.00	36.30	470.00	74.00	940.00	92.70
4.00	3.65	8.70	7.26	44.00	24.10	91.00	36.50	480.00	74.50	950.00	93.00
4.10	3.73	8.80	7.33	45.00	24.40	92.00	36.70	490.00	75.00	960.00	93.30
4.20	3.82	8.90	7.40	46.00	24.80	93.00	36.90	500.00	75.60	970.00	93.60
4.30	3.90	9.00	7.47	47.00	25.10	94.00	37.10	510.00	76.10	980.00	93.80
4.40	3.98	9.10	7.54	48.00	25.40	95.00	37.30	520.00	76.60	990.00	94.10
4.50	4.07	9.20	7.61	49.00	25.70	96.00	37.50	530.00	77.10	1000.00	94.40
4.60	4.15	9.30	7.68	50.00	26.10	97.00	37.70	540.00	77.60	2000.00	114.40
4.70	4.23	9.40	7.75	51.00	26.40	98.00	37.90	550.00	78.10	3000.00	126.60

known, then this factor should be in the numerators of equations 16 through 19. For wavelengths between 330 to 400 nm and between 1400 nm and 4200 nm optical glass transmits some radiation and equations 11 through 14 apply if the 0.7 cm is replaced by 0.1 cm.

**EXAMPLE 26.**

View the diffuse reflection of the ruby laser flash through a pair of 10 × 50 binoculars (i.e., Example 23, P = 10 and D<sub>o</sub> = 50 mm). For night viewing find the relative hazard to the human eyes. Since the exit pupil is D<sub>o</sub>/P = 0.5 cm, equation 19a estimating D<sub>e</sub> to be 0.7 cm will give—

$$G = \frac{(5 \text{ cm})^2}{(10)^2(0.7 \text{ cm})^2} = \frac{25 \text{ cm}}{(100)(0.49 \text{ cm})} = 0.51 \text{ cm}$$

The hazard is equivalent to a corneal radiant exposure on the naked eye of: (0.51) (1.91 × 10<sup>-8</sup> J·cm<sup>-2</sup>) = 9.7 × 10<sup>-9</sup> J·cm<sup>-2</sup> = 9.7 nJ·cm<sup>-2</sup>.

**EXAMPLE 27.**

View a specularly reflected visible laser beam at a point where the beam radiant exposure measures 2 × 10<sup>-9</sup> J·cm<sup>-2</sup> (2.0 nJ·cm<sup>-2</sup>). If an operator were to view the beam through a pair of 7 × 50 binoculars, what would the relative hazard be compared with unaided viewing? The magnification, P, of the binoculars is 7 and, if inserted in equation 12, will provide the simplest solution:

$$G = P^2 = 7^2 = 49$$

Thus, the operator would be viewing a level up to 49 times greater than by the naked eye, or a corneal radiant exposure of nearly 10<sup>-7</sup> J·cm<sup>-2</sup> (0.1 μJ·cm<sup>-2</sup>).

**E-18. Corneal Radiant Exposure for Single Exposure from a Scanning Laser Beam.** Repetitive pulsed exposures depend upon geometrical considerations, scan rate, and frame rate.

(20a & 20b)

$$H = \frac{1.27 \Phi e^{-\mu r}}{(a + r\phi)^2} \cdot \frac{d_e}{rS\theta_s} \quad \text{for } d_e > (a + r\phi)$$

or

$$H = \frac{1.27 \Phi e^{-\mu r}}{(a+r\phi)(rS\theta_s)} \quad \text{for } d_e \leq (a+r\phi)$$

For the applicable exposure limits refer to the repetitive nature of the exposure and the exposure duration of a single pulse where—

(21a & 21b)  $t = \frac{(a+r\phi)}{rS\theta_s}$  for  $d_e \leq (a+r\phi)$

or

$$t = \frac{d_e}{rS\theta_s} \quad \text{for } d_e > (a+r\phi)$$

and the PRF is  $S$  if each scan passes over the eye.

**EXAMPLE 28.**

Find the exposure of a scanning HeNe laser system having the following parameters:

$$\begin{aligned} a &= 0.1 \text{ cm}, \phi = 5 \text{ mrad}, \Phi = 5 \text{ mW}, \\ \theta_s &= 0.1 \text{ rad}, \text{ and } S = 30 \text{ scans/s for an} \\ &\text{intrabeam viewing distance } r = 200 \\ &\text{cm.} \end{aligned}$$

**STEP 1.** The beam diameter  $D_L = (a + r\phi) = (0.1 + 1) = 1.1 \text{ cm}$ , hence apply the  $H$  and  $t$  equations shown above.

**STEP 2.** The PRF at the eye is 30 pulses per second and the exposure time is—

$$t = \frac{0.1 + (200)(5 \times 10^{-3})}{(200)(30)(0.1)} = \frac{1.1}{600} = 1.8 \text{ ms.}$$

**STEP 3.** The radiant exposure is—

$$H = \frac{(1.27)(5 \times 10^{-3})(1)}{(0.1 + 1)(200)(30)(0.1)} = 9.6 \mu\text{J}\cdot\text{cm}^{-2}.$$

**STEP 4.** The average irradiance at the cornea is—

$$E_{\text{avg}} = H \cdot S = (9.6 \times 10^{-6})(30) = 0.29 \text{ mW}\cdot\text{cm}^{-2}$$

**STEP 5.** The applicable exposure limit for a 0.25 s exposure is determined by the cumulative exposure of almost eight pulses, or  $(8)(9.6 \times 10^{-6} \text{ J}\cdot\text{cm}^{-2}) = 77 \mu\text{J}\cdot\text{cm}^{-2}$ . This radiant exposure must be compared with the exposure limit for a single pulse of duration  $t = (8)(1.8 \text{ ms}) = 15 \text{ ms}$ , which from figure C-1a, or by calculation (Example 1) is  $77 \text{ J}\cdot\text{cm}^{-2}$ . Hence, the exposure is permissible for momentary (unintentional) viewing.

**E-19. Exposure Limit from a Multiwavelength Laser.** Calculating the exposure from a multiple wavelength laser requires a knowledge of the relative irradiance or radiant exposure from each wavelength present. If each wavelength has a different divergence then the composite exposure level will also be a function of the distance from the laser. The following relationships may be used at any particular distance:

(22a & 22b)  $EEL = \Sigma Ei / \Sigma (Ei/ELi)$

$$EEL = \Sigma Hi / \Sigma (Hi/ELi)$$

**EXAMPLE 29.**

Determine the effective exposure limit (EEL) for single-pulse exposure to a Nd:YAG laser that is frequency doubled and emits 70 mJ at 1064 nm and 10 mJ at 532 nm. The pulse width is 10 ns and  $a = 1 \text{ cm}$ . Since both laser wavelengths are in the retinal hazard region (400 nm to 1400 nm), the EEL must account for the additivity of the two wavelengths. The EEL depends on the relative amounts of each wavelength in the total laser output. The above laser is not as hazardous as an 80 mJ laser operating at 532 nm or as safe as an 80 mJ laser operating at 1064 nm. The EEL may be calculated from the following:

$$EEL = \Sigma H_i / \Sigma H_i / EL_i$$

where—

$H_i = D_L$  radiant exposure averaged over 7 mm if  $a \leq 7 \text{ mm}$ ; if  $a > 7 \text{ mm}$  then average over  $a$ .

$EL_i =$  the exposure limits for each wavelength.

$$\begin{aligned} H_1 &= \frac{7 \times 10^{-2} \text{ J}}{\pi (1)^2 / 4} = (1.27)(7 \times 10^{-2}) \\ &= 8.9 \times 10^{-2} \text{ J}\cdot\text{cm}^{-2} \end{aligned}$$

$$H_2 = \frac{10^{-2} \text{ J}}{(1)^2 / 4} = 1.27 \times 10^{-2} \text{ J}\cdot\text{cm}^{-2}$$

$$\begin{aligned} \Sigma H_i &= 8.9 \times 10^{-2} + 1.27 \times 10^{-2} \\ &= 1.02 \times 10^{-1} \text{ J}\cdot\text{cm}^{-2} \end{aligned}$$

$$EL_1 = 5 \times 10^{-6} \text{ J}\cdot\text{cm}^{-2}$$

$$EL_2 = 5 \times 10^{-7} \text{ J}\cdot\text{cm}^{-2}$$

$$\frac{H_1}{EL_1} = \frac{8.9 \times 10^{-2} \text{ J}\cdot\text{cm}^{-2}}{5 \times 10^{-6} \text{ J}\cdot\text{cm}^{-2}} = 1.78 \times 10^4 \text{ J}\cdot\text{cm}^{-2}$$

$$\frac{H_2}{EL_2} = \frac{1.27 \times 10^{-2} \text{ J}\cdot\text{cm}^{-2}}{5 \times 10^{-7} \text{ J}\cdot\text{cm}^{-2}} = 2.5 \times 10^4 \text{ J}\cdot\text{cm}^{-2}$$

$$\begin{aligned} \Sigma H_i / EL_i &= 1.78 \times 10^4 + 2.5 \times 10^4 \\ &= 4.3 \times 10^4 \text{ J}\cdot\text{cm}^{-2} \end{aligned}$$

$$\begin{aligned} EEL &= \Sigma H_i / \Sigma H_i / EL_i \\ &= \frac{1.02 \times 10^{-1} \text{ J}\cdot\text{cm}^{-2}}{4.3 \times 10^4} \\ &= 2.37 \times 10^{-6} \text{ J}\cdot\text{cm}^{-2} \end{aligned}$$

**E-20. Optical Density Necessary for Protection from Intrabeam Viewing of Lasers.** Calculating the necessary optical density for a particular laser device requires a knowledge of the output power or energy and the irradiance or radiant exposure. Generally two values are calculated, although specific values of optical density may be calculated at any distance in front of the laser. When optical aids are not used and the provisions of appendix F are met, the following relationship may be used when E and H are averaged over 7 mm.

(23a & 23b)

$$\begin{aligned} OD &= \log_{10} \left( \frac{E}{EL} \right) \\ OD &= \log_{10} \left( \frac{H}{EL} \right) \end{aligned}$$

### Section V. SUMMARY OF EQUATIONS

**E-21. Equation 1.** Exposure limit for visible pulsed lasers  $18 \mu\text{s} \leq t \leq 10 \text{ s}$ .

**E-22. Equation 2.** Exposure limit for near infrared pulsed lasers (1049–1400 nm).

When optical aids are used, the entire beam may enter a persons eye, therefore the following relationships are used.

$$\begin{aligned} (24a \ \& \ 24b) \ OD &= \log_{10} \left( \frac{\Phi}{(0.4)(EL)} \right) \\ OD &= \log_{10} \left( \frac{Q}{(0.4)(EL)} \right) \end{aligned}$$

**EXAMPLE 30. Calculating Optical Density.**

Calculate the optical density necessary from a 50 mJ ruby laser with a 1 cm beam diameter at the laser port.

For unaided viewing—

$$\begin{aligned} H &= (2.6)(0.05) \left[ 1 - e^{-1/2(1)^2} \right] \\ &= 5.1 \times 10^{-2} \text{ J}\cdot\text{cm}^{-2} \\ OD &= \log_{10} \left( \frac{5.1 \times 10^{-2}}{5 \times 10^{-7}} \right) = 5.0 \end{aligned}$$

Goggles with an optical density greater than 5.0 would provide protection when optics are not used. For optically aided viewing—

$$OD = \log_{10} \left[ \frac{0.05}{(0.04)(5 \times 10^{-7})} \right] = 5.4$$

Goggles with an optical density greater than 5.4 would provide protection when optics are used.

E-24. Equation 4. Laser beam diameter downrange from laser.

$$D_L = a + r\phi$$

E-25. Equation 5. Integrated radiance,  $L_p$ , as a function of radiant exposure,  $H$ , on a perfect diffuse surface; and radiant exposure as a function of integrated radiance from the illuminated spot.

$$L_p = \frac{H\rho_\lambda}{\pi}$$

$$H = \frac{\pi L_p}{\rho_\lambda}$$

E-26. Equation 6. Central beam irradiance,  $E_o$ , and radiant exposure,  $H_o$ .

$$H_o = \frac{1.27Q}{a^2}$$

$$E_o = \frac{1.27\Phi}{a^2}$$

E-27. Equation 7. Central beam irradiance,  $E_o$ , and radiant exposure,  $H_o$ , averaged over a 7-mm aperture.

$$E_o = 2.6\Phi \left[ 1 - e^{-1/2a^2} \right]$$

$$H_o = 2.6Q \left[ 1 - e^{-1/2a^2} \right]$$

E-28. Equation 8. Beam diameter in relation to fraction of total beam power passing through an aperture for Gaussian beam.

$$a = \sqrt{\frac{-d^2}{\ln[1 - f(x)]}}$$

$$D_L = \sqrt{\frac{-d^2}{\ln[1 - f(x)]}}$$

E-29. Equation 9. Beam divergence in relation to the initial beam diameter and the beam diameter downrange.

$$\phi = \frac{D_L - a}{r}$$

E-30. Equation 10. Fraction of beam power passing through aperture.

$$f(x) = 1 - e^{-d^2/a^2}$$

E-31. Equation 11. Beam irradiance,  $E$ , or radiant exposure,  $H$ , for nondiverging beam at range,  $r$ .

$$E = E_o e^{-\mu r}$$

$$H = H_o e^{-\mu r}$$

E-32. Equation 12. Average irradiance,  $E$ , at range,  $r$ , (direct circular beam) or radiant exposure,  $H$ , at range.

$$E = \frac{1.27\Phi e^{-\mu r}}{(a + r\phi)^2}$$

$$H = \frac{1.27Q e^{-\mu r}}{(a + r\phi)^2}$$

E-33. Equation 13. Minimum beam diameter at range,  $r$ .

$$D_L = a + r\phi \quad \text{for small } \phi$$

E-34. Equation 14. Nominal ocular hazard distance from a CW laser or a pulsed laser in a vacuum.

$$\text{NOHD}(v) = 1/\phi \left\{ \sqrt{\frac{1.27\Phi}{EL}} - a \right\}$$

$$\text{NOHD}(v) = 1/\phi \left\{ \sqrt{\frac{1.27Q}{EL}} - a \right\}$$

} without atmospheric attenuation

E-35. Equation 15. Reflected irradiance,  $E$ , or radiant exposure,  $H$ , for diffuse reflector (for  $r_1 \gg D_L$ ).

$$E = \frac{\Phi\rho_\lambda \cos\theta v}{\pi r_1^2}$$

$$H = \frac{Q\rho_\lambda \cos\theta v}{\pi r_1^2}$$

E-36. Equation 16. Optical gain factor for direct viewing.

$$G = 2.04 D_o^2 \quad 0.7 \text{ cm} \geq D_e$$

$$G = \frac{D_o^2}{D_e^2} = p^2 \quad 0.7 \text{ cm} \leq D_e$$

**TB MED 524**

**E-37. Equation 17.** Nominal ocular hazard distance when optical aids are used (NOHD\*) in vacuum.

$$\text{NOHD}^*(v) = 1/\phi \left\{ \sqrt{\frac{1.27\phi G}{EL}} - a \right\}$$

$$\text{NOHD}^*(v) = 1/\phi \left\{ \sqrt{\frac{1.27Q\phi}{EL}} - a \right\}$$

**E-38. Equation 18.** Corneal irradiance or radiant exposure averaged over 7-mm on an individual's eye when optical aids are used.

$$\left. \begin{aligned} E_o &= 2.6\phi \left[ 1 - e^{-D_o^2/D_L^2} \right] e^{-\mu r} \\ H_o &= 2.6Q \left[ 1 - e^{-D_o^2/D_L^2} \right] e^{-\mu r} \end{aligned} \right\} D_e \leq 7 \text{ mm}$$

$$\left. \begin{aligned} E_o &= \frac{1.27\phi}{D_e^2} \left[ 1 - e^{-D_o^2/D_L^2} \right] e^{-\mu r} \\ H_o &= \frac{1.27Q}{D_e^2} \left[ 1 - e^{-D_o^2/D_L^2} \right] e^{-\mu r} \end{aligned} \right\} \begin{array}{l} D_e > 7 \text{ mm} \\ \text{and} \\ D_L > D_o \end{array}$$

**NOTE**

When  $D_L < D_o$ , the first two equations should be used.

**E-39. Equation 19.** Optical gain factor for indirect view.

$$G = \frac{D_o^2}{P^2(0.7)^2} \leq 1 \quad 0.7 \text{ cm} \geq D_e$$

$$G = \frac{D_o^2}{P^2 D_e^2} = 1 \quad 0.7 \text{ cm} \leq D_e$$

**E-40. Equation 20.** Corneal radiant exposure for single exposure from a scanning laser beam.

$$H = \frac{1.27\phi e^{-\mu r}}{(a + r\phi)^2} \cdot \frac{d_e}{rS\theta_s} \quad d_e > (a + r\phi)$$

$$H = \frac{1.27\phi e^{-\mu r}}{(a + r\phi)rS\theta_s} \quad d_e < (a + r\phi)$$

**E-41. Equation 21.** Exposure duration of a single pulse from a scanning laser.

$$t = \frac{(a + r\phi)}{rS\theta_s} \quad d_e \leq (a + r\phi)$$

$$t = \frac{d_e}{rS\theta_s} \quad d_e > (a + r\phi)$$

**E-42. Equation 22.** Exposure limit for multiple wavelength lasers.

$$\text{EEL} = \Sigma E_i / \Sigma (E_i / EL_i)$$

$$\text{EEL} = \Sigma H_i / \Sigma (H_i / EL_i)$$

**E-43. Equation 23.** Optical density necessary for protection against direct viewing of a laser beam when optical aids are not used.

$$\text{OD} = \log_{10} \left( \frac{E}{EL} \right)$$

$$\text{OD} = \log_{10} \left( \frac{H}{EL} \right)$$

**E-44. Equation 24.** Optical density necessary for protection against direct viewing of a laser beam when optical aids are used.

$$\text{OD} = \log_{10} \left( \frac{\Phi}{(0.4)(EL)} \right)$$

$$\text{OD} = \log_{10} \left( \frac{Q}{(0.4)(EL)} \right)$$



## APPENDIX F

### LASER PROTECTIVE EYEWEAR

**F-1. Background.** Laser protective eyewear is presently available from several commercial sources and in many varieties. A standard anti-laser goggle is being developed by the Army. Several factors should be considered in determining whether eyewear is necessary and, if so, selecting the proper eyewear for a specific situation. At least two output parameters of the laser must be known, and knowledge of environmental factors such as ambient lighting and the nature of the laser operation is also required. Laser eye protection generally consists of a filter plate or stack of filter plates, or two filter lenses that selectively attenuate at specific laser wavelengths, but transmit as much visible radiation as possible. Eyewear is available in several designs: Spectacles, coverall types with opaque side-shields, coverall types with somewhat transparent side-shields, aviator frames with no side-shields, and laboratory style with flat glass absorbers.

**F-2. Operational Requirements for Laser Eye Protection.** *a.* The experience gained by the USAEHA from evaluating ocular hazards of a large variety of field and laboratory lasers shows that *requirements for eye protection vary considerably*. The primary usefulness of laser eye protection is in testing of and training with laser devices.

*b.* Laser eye protectors are normally not recommended for *flight crews of aircraft* equipped with laser rangefinders and target designators. The added hazards resulting from loss of peripheral vision, reduced visual transmission, and degraded color contrast from most types of goggles may outweigh the protection afforded by such goggles from the normally very low probability of exposure from a reflected laser beam. However, if a hazardous specular reflection is likely to be directed toward the aircraft, or if a laser beam is to be intentionally directed at the aircraft then aviators can be required to wear eye protectors with high visual transmission. (Side-shields, which reduce peripheral vision, may not be necessary due to the very low probability of a hazardous double reflection exposure at typical engagement ranges.)

*c.* At present, it is felt that *armored vehicle crews* do not require personal eye protection within vehicles. However, magnifying optical devices within armored vehicles which could transmit the beam to a crewmember should be equipped with laser protective filters. If armored crews were to be outside of the vehicle, personal eye protectors are desirable in certain instances where specular reflections are expected. If an armored vehicle is the target in laser tests or

exercises, personal eye protection for the driver, the commander, and other exposed personnel may be required.

*d.* In *test and training activities*, eye protection has been required for personnel downrange within the laser beam target area and for other personnel if the target area cannot be cleared of specular reflective surfaces. However, the more desirable hazard control procedure of removing specular targets from range target areas eliminates the requirement for eye protection for all but the personnel within the target area.

*e.* For *indoor shop or laboratory environments*, eye protection is required for Class 4 lasers and where specular reflections of Class 3 lasers are not controlled. However, eye protection has not been recommended for holographic viewing and optical alignment procedures if reasonable precautions are taken.

*f.* If *curved protective filters* are required for personnel in a laser target area, personnel in the vicinity of the laser and elsewhere would not also require eye protection. Potentially hazardous specular reflections can exist to significant distances from flat-lens surfaces. Hence, the curved filters are far more desirable than flat-lens filters.

*g.* Proper *indoctrination of laser operators* not to fire at personnel and the low probability of exposure to a specular reflection should preclude the need for laser eye protection from US laser equipment in combat, except in unusual instances.

*h.* Recommendations for operational hazard controls and eye protection requirements for *specific Army laser systems* are given in AR 385-63.

**F-3. Eyewear Parameters.** The factors that shall be considered before choosing laser safety eyewear are:

*a. Wavelength.* The wavelength(s) of laser radiation limits the type of eye shields to those that prevent the particular wavelength(s) from reaching the eye. It is emphasized that many lasers emit more than one wavelength and that each wavelength shall be considered. Considering the wavelength corresponding to the greatest output intensity is not always adequate. For instance, a helium-neon laser may emit 100 mW at 632.8 nm and only 10 mW at 1150 nm, but safety goggles which absorb the 632.8-nm wavelength may absorb relatively little or essentially nothing at the 1150-nm wavelength.

*b. Optical density.* Optical density is a parameter for specifying the attenuation afforded by a given thickness of any transmitting medium. Since laser beam intensities may be a factor of a thousand or a

million above safe exposure levels, *percent transmission* notation can be unwieldy. For instance, goggles with a transmission of 0.000001 percent can be described as having an optical density of 8.0. Optical density (OD) is a logarithmic notation and is de-

scribed in the following (mathematical) expression:

$$OD = \log_{10} \left( \frac{I_0}{I} \right), \text{ see table 4-1.}$$

Where  $I_0$  is the irradiance or radiant exposure of the

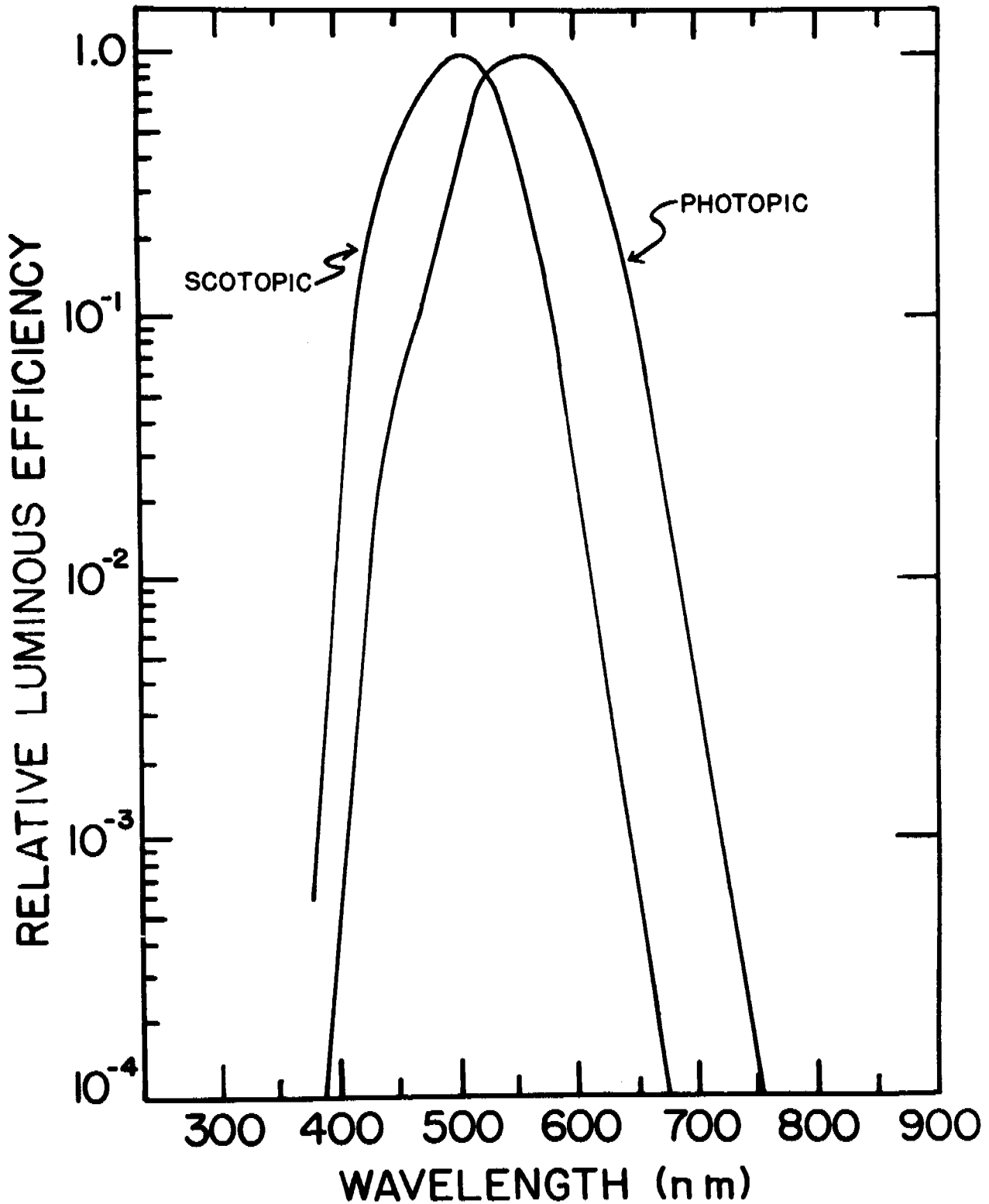

Figure F-1. Photopic (day vision) and scotopic (night vision) visual response.

incident beam and  $I$  is the irradiance or radiant exposure of the transmitted beam. Thus, a filter attenuating a beam by a factor of 1000 or  $10^3$  has an optical density of 3, and attenuating a beam by 1,000,000 or  $10^6$  requires an optical density of 6. The required optical density is determined by the maximum laser beam irradiance or radiant exposure to which the individual could be exposed. The optical density of two highly absorbing filters when stacked is essentially the sum of two individual optical densities.

*c. Laser beam intensity.* The maximum laser beam radiant exposure in  $\text{J}\cdot\text{cm}^{-2}$  for pulsed lasers or maximum laser beam irradiance in  $\text{W}\cdot\text{cm}^{-2}$  for continuous-wave lasers cannot always be readily determined. If the beam is never focused and is larger than the diameter of the eye's pupil, the output energy per unit area or power per unit area should be the guiding value. If the beam is focused or if the beam cannot be observed at the output, the maximum total beam energy or power output shall be used.

*d. Visible transmittance of eyewear.* Since the object of laser protective eyewear is to filter out the laser wavelengths while transmitting as much of the visible light as possible, visible (or luminous) transmittance should be noted. A low visible transmittance (usually measured in percent) creates problems of eye fatigue and may require an increase in ambient lighting in laboratory situations. However, adequate optical density at the laser wavelengths should not be sacrificed for improved visible transmittance. For nighttime viewing conditions, the effective visible transmittance will be different since the spectral response of the eye is different. Figure F-1 shows the scotopic (night vision) and photopic (day vision) responses of the eye. Blue-green filter lenses, therefore, have higher scotopic transmission values than red or orange lenses and vice-versa.

*e. Laser filter damage threshold (maximum irradiance).* At very high beam intensities, filter materials which absorb the laser radiation are damaged; thus, it becomes necessary to consider a damage threshold for the filter. Typical damage thresholds from Q-switched pulsed laser radiation fall between 10 and  $100 \text{ J}\cdot\text{cm}^{-2}$  for absorbing glass and  $1 \text{ J}\cdot\text{cm}^{-2}$  and  $10 \text{ J}\cdot\text{cm}^{-2}$  for plastics and dielectric coatings. Irradiances from CW lasers which would cause filter damage are in excess of those which would present a serious fire hazard and, therefore, need not be considered (i.e., personnel should not be permitted in the area of such lasers).

**F-4. Methods of Construction.** *a.* There are basically two effects that are utilized to selectively filter out laser wavelengths. Filters are designed to make use

of selective spectral absorption by colored glass or plastic, or selective reflection from dielectric coatings on glass, or both. Each method has its advantages.

*b.* The simplest method of fabrication is to use colored glass absorbing filters that are generally the most effective in resisting damage from wear and from very intense laser sources. Unfortunately, most absorbing filters are not case-hardened to provide impact resistance, but clear plastic sheets are generally placed behind the glass filter.

*c.* The advantage of using reflective coatings is that they can be designed to selectively reflect a given wavelength while transmitting as much of the rest of the visible light as possible. However, some angular dependence of the spectral attenuation factor is generally present.

*d.* The advantages of using absorbing plastic filter materials are greater impact resistance, lighter weight, and ease of molding into curved shapes. The disadvantages are that they are more readily scratched, quality control appears to be more difficult, and the organic dyes used as absorbers are more readily affected by heat and ultraviolet radiation and may saturate or bleach under Q-switched laser irradiation.

#### **F-5. Selecting appropriate eyewear.**

**STEP 1.** Determine wavelength(s) of laser output.

**STEP 2.** Determine required optical density (table 4-1) or required optical densities (or alternatively dB of attenuation, or attenuation factors) for various laser beam intensities that could be incident upon safety eyewear. To determine the maximum incident beam intensity, consider the following:

*a.* If the emergent beam is not focused down to a smaller spot, and is greater than 7 mm in diameter, the emergent beam radiant exposure or irradiance may be considered the maximum intensity that could reach the unprotected eye, and is thus used in table 4-1.

*b.* If the emergent beam is focused after emerging from the laser system or if the emergent beam diameter is less than 7 mm in diameter, assume that all of the beam energy or power could enter the eye. In this case, divide the laser output energy or power by the maximum area of the pupil (approximately  $0.4 \text{ cm}^2$ ). This radiant exposure or irradiance may be used in table 4-1.

*c.* If the observer is in a fixed position and cannot receive the maximum output radiant exposure or irradiance, then a measured value may be used (e.g., downrange from laser beam).

## APPENDIX G

### FIRST AID PROCEDURES FOR INCLUSION IN LASER SOPs

**G-1. First Aid Procedures for Electrical Shock Victims.** *a.* Before touching a victim of electric shock, the circuit should be deenergized or the victim should be freed from the live conductor by using some suitable nonconductive object such as a rope, dry wooden stick, or insulated pole. Cardiopulmonary resuscitation (CPR) procedures appropriate to the victim's condition shall be started immediately.

*b.* First establish the unresponsiveness of the victim by tapping, gentle shaking, and shouting. Call out for help. If unresponsive, place your ear near the victim's nose. Listen for breath sounds, feel for breathing on your cheek, and look for chest movement indicating breathing. If no breathing is apparent, position the patient as in paragraph *c* and give four short breaths by mouth to mouth ventilation. Then palpate the neck for the carotid pulse. If no spontaneous breathing is present, begin mouth to mouth ventilation (para *c*). If no carotid pulse is present, begin external cardiac compression (para *d*).

*c.* Mouth-to-mouth resuscitation may be performed as follows:

(1) *Place the victim on his or her back.* Place on a firm surface such as the floor or ground, not on a bed or sofa.

(2) *Tilt the victim's head straight back.* Extend the neck up as far as possible. (This will automatically keep the tongue out of the airway.)

(3) *Open your mouth wide and place it tightly over the victim's mouth.* At the same time, pinch the victim's nostrils shut, or close the nostrils with your cheek, or close the victim's mouth and place your mouth over his or her nose.

(4) *Blow into the victim's mouth, or nose,* with a smooth steady action until the victim's chest is seen to rise.

(5) *Remove your mouth.* Allow the victim to exhale passively and watch the victim's chest fall.

(6) *Repeat.* This cycle should be continued at the rate of one breath each 5 seconds.

#### WARNING

If you are not getting an air exchange, quickly recheck the position of the head and the adequacy of the seal around the mouth. If attempts to ventilate are still unsuccessful, sweep your fingers through the victim's mouth and into his or her throat to remove any foreign bodies. If the rescuer is unable to dislodge the foreign body, turn the victim on his or her side and give several sharp blows between the shoulder blades to jar it free. After four quick breaths, stop and de-

termine if the heart is beating by gently feeling the carotid pulse. If the heart is beating, return to the mouth.

*d.* External cardiac compression, if necessary, may be performed as follows:

(1) If the carotid pulse is absent or questionable, start artificial circulation by external cardiac compression.

(2) Place the heel of one hand on the lower one half of the breastbone and the other hand on top of the first.

(3) Thrust downward from your shoulders with enough force to depress the breastbone about 1½ to 2 inches.

(4) Relax immediately after each downstroke to permit natural expansion of the chest.

(5) Repeat at the rate of about one downstroke per second. The compressions must be regular, smooth, and uninterrupted. If you are alone with the victim, you must alternate mouth-to-mouth breathing with external cardiac compression at the ratio of about 2 to 15 (two breaths, then 15 heart compressions). If you have help, the ratio is five compressions to one inflation. Continue one or both of the above while the victim is being transported to the hospital, until patient revives, or until told to stop by a physician.

(6) Once the victim is breathing again, treat for physical shock if symptoms are present.

**G-2. Treatment for Shock.** If the patient is pale, cold, sweaty, weak and has a rapid pulse, treat by—

*a. Laying the patient down.*

*b. Loosening the patient's clothes.*

*c. Keeping the patient warm.*

*d. Elevating the patient's legs.*

*e. Keeping the patient quiet.*

**G-3. First Aid for Eye Injury from Laser Energy.**

First aid should not be attempted for damage produced by laser energy to the eye; therefore, prompt reporting to a medical treatment facility is imperative for known or suspected laser injuries. Report injuries to Occupational Health Section, Bldg \_\_\_\_\_, during regular duty hours; during weekends, holidays and after regular duty hours report to walk-in clinic, XYZ Army Community Hospital, Bldg \_\_\_\_\_, for treatment. For ambulance service call \_\_\_\_\_. Telephone number for Occupational Health Section is \_\_\_\_\_.

**G-4. First Aid for Eye Injury from Caustic Chemicals.** A deluge type eye wash and/or shower shall be

## TB MED 524

provided in a readily accessible location. Personnel are to flush the eye(s) for approximately 15 to 20 minutes and then report promptly to a medical treatment facility.

**G-5. First Aid for Skin Contact with Caustic Chemicals.** Immediately flush the skin with large quantities of water. Report to a medical treatment facility for medical care.

**G-6. First Aid for Airborne Exposure to Asphyxiants and Toxic Gases (cryogenics, carbon monoxide, etc.).** *a.* Remove the individual from the contaminated environment as quickly as possible. The rescuers shall use a buddy system and be provided with adequate self contained breathing apparatus in a contaminated atmosphere.

*b.* If the person has stopped breathing, begin mouth-to-mouth ventilation. Quickly check to see if the victim's heart is beating; if the carotid pulse is absent, begin external cardiac compression. Continue CPR measures until relieved by trained medical personnel.

**G-7. First Aid for Burns.** Cover the burned area and keep it clean. Treat for physical shock if necessary.

**G-8. First Aid for Cryogenic Caused Frostbite.** Cover the affected area and keep it clean. Prohibit smoking. If the lower extremity is involved, treat as a litter patient with the affected part level or slightly elevated. Have the patient transported to a medical facility for emergency treatment.

## GLOSSARY

## Section I. ABBREVIATIONS

AEL	accessible emission limit
AIT	advanced individual training
ANSI	American National Standards Institute
CPR	cardiopulmonary resuscitation
CO <sub>2</sub>	carbon dioxide
CW	continuous wave
EL	exposure limit
EEL	effective exposure limit
FM	field manual
GDL	gas dynamic laser
GTL	gas transport laser
Hz	Hertz
IR-A	infrared-"A"
IMA	installation medical authority
J	joule
km	kilometer
kV	kilovolt
LAIR	Letterman Army Institute of Research
LASER	light amplification by stimulated emission of radiation
LRF	laser rangefinder
LRSO/NCO	laser range safety officer/noncommissioned officer
LSDZ	laser safety danger zone
mm	millimeter(s) ( $1 \times 10^{-3}$ meter(s))
ms	millisecond(s)
mW	milliwatt(s)
$\mu$ m	micrometer(s) ( $1 \times 10^{-6}$ meter(s))
NATO	North Atlantic Treaty Organization
nm	nanometer(s) ( $1 \times 10^{-9}$ meter(s))
NOHD	nominal ocular hazard distance
OD	optical density
PRF	pulse repetition frequency
RDTE	research, development, testing, and evaluation
s	second(s)
SOP	standing operating procedure
sr	steradian
STANAG	international standardization agreement
TEM	transverse electromagnetic wave
TM	technical manual
UV	ultraviolet
USAEHA	US Army Environmental Hygiene Agency
W	watt(s)

## Section II. TERMS

*Accessible Emission Limit (AEL)*

Maximum accessible emission level within a particular class.

*Accommodation*

Ability of the eye to change its power and thus focus for different object distances.

*AEL for Class 1*

That radiant power or energy of a laser under consid-

eration such that no applicable exposure limit for exposure of the eye for a specified exposure duration can be exceeded under any possible viewing conditions with or without optical instruments, whether or not the beam is focused (app D).

*Angstrom (A)*

Unit of measure of wavelength equal to  $10^{-10}$  meter, 0.1 nanometer, or  $10^{-4}$  micrometer.

*Area T*

Hazardous area for viewing a diffuse reflection of an emergent laser beam in front of a laser.

*Area S*

Potentially hazardous zone for specular reflections around a target.

*Attenuation*

Decrease in the radiant flux of any optical beam as it passes through an absorbing or scattering medium.

*Beam Diameter ( $D_L$ )*

The distance between diametrically opposed points in the cross-section of a circular beam where the power per unit area is 1/e times (37 percent) that at the peak.

*Beam Divergence ( $\phi$ )*

Angle of beam spread measured in radians or milliradians (1 milliradian = 3.4 minutes of arc or approximately 1 mil). For small angles where the chord is approximately equal to the arc, the increase in the diameter of the beam is numerically equal to 1,000th of the range in meters multiplied by the number of milliradians of beam divergence (i.e., at 1,000 meters range a beam divergence of 2 milliradians would give a beam diameter 2 meters wider than the emergent beam diameter).

*Beam Splitter*

An optical device using controlled reflection to produce two beams from a single incident beam.

*Biennial Vision Screening Examination*

Vision screening examination using multiphasic vision screening equipment every 2 years.

*Closed Installation*

Any location where lasers are used that will be closed to unprotected personnel during laser operation.

*CW Laser*

Continuous wave laser, as distinguished from a pulsed laser. A laser emitting for a period in excess of 0.25 second.

*Controlled Area*

An area where the occupancy and activity of those within are subject to control and supervision for the purpose of protection from optical radiation hazards.

*Diffuse Reflection*

Takes place when different parts of a beam incident on a surface are reflected over a wide range of angles.

*Distance Z*

Downrange distance along the approved lines of sight; Distance Z is always greater than or equal to the NOHD.

*Duty-cycle*

Ratio of "on time" to total exposure duration for a repetitively pulsed laser.

*Electromagnetic Radiation*

The propagation of varying electric and magnetic fields through space at the velocity of light.

*Emergent Beam Diameter ( $a$ )*

Diameter of the laser beam at the exit aperture of the system in centimeters (cm); for a Gaussian beam, the diameter at 1/e peak intensity values.

*Enclosed Laser System*

Any laser or laser system located within an enclosure which does not permit emission of hazardous optical radiation from the enclosure.

*Extended Source*

An extended source of radiation can be resolved into a geometrical image in contrast with a point source of radiation, which cannot be resolved into a geometrical image. For the purposes of this bulletin, a source which subtends an angle greater than  $\alpha_{\min}$  (symbols, app E).

*Gas Laser*

A type of laser in which the laser action takes place in a gas medium, usually operated as a CW laser.

*Hertz (Hz)*

Unit of frequency (i.e., "cycles per second").

*Infrared Radiation (IR)*

Electromagnetic radiation with wavelengths which lie within the range of 0.7 to 1000  $\mu\text{m}$ . This region is often broken into three spectral bands by wavelength: IR-A (0.7–0.78 to 1.4  $\mu\text{m}$ ), IR-B (1.4  $\mu\text{m}$  to 3.0  $\mu\text{m}$ ), and IR-C (3  $\mu\text{m}$  to 1 mm).

*Installation Medical Authority*

Refers to the unit surgeon, command chief surgeon, US Army Medical Department activity/US Army medical center commanders, and the director of the health services or his or her representative responsible for provision of medical support at the unit, command, or installation concerned.

*Integrated Radiance ( $L_p$ )*

Product of the exposure duration times the radiance. Also known as pulsed radiance ( $\text{W}\cdot\text{s})(\text{cm}^{-2}\cdot\text{sr}^{-1}) = \text{J}\cdot\text{cm}^{-2}\cdot\text{sr}^{-1}$ .

*Intensity*

Radiant exposure or irradiance.

*Intrabeam Viewing*

Viewing the laser source from within the beam. The beam may either be direct or specularly reflected.

**Irradiance (E)**

Power per unit area on a given surface, in units of watts-per-square-centimeter ( $W \cdot cm^{-2}$ ).

**Joule (J)**

A unit of energy (1 watt-second) used normally in describing a single pulsed output of a laser; it is equal to 1 watt-second or 0.239 calories.

**Joule·cm<sup>-2</sup> ( $J \cdot cm^{-2}$ )**

A unit of radiant exposure used in measuring the amount of energy-per-unit-area of absorbing surface or per unit area of a laser beam.

**Lambertian Surface**

An ideal diffuse surface whose emitted or reflected radiance (brightness) is independent of the viewing angle.

**Laser**

A source of intense, coherent and directional optical radiation. Also, an acronym for *light amplification by stimulated emission of radiation*. A laser usually is composed of an energy source, a resonant cavity, and an active lasing medium.

**Laser Device**

Either a laser or a laser system.

**Laser Range Safety Officer/NCO (LRSO/NCO)**

Direct representative of the individual in charge of laser operations; can be either a qualified civilian or military person.

**Laser Safety Danger Zone (LSDZ)**

The ground area that requires control during laser operation. Unauthorized personnel are not permitted and laser eye protectors are required for personnel who may engage in intrabeam viewing within this area.

**Laser System**

An assembly of electrical, mechanical, and optical components that includes a laser.

**Laser Controlled Area**

Any area that contains one or more lasers and the activity of personnel is subject to control and supervision.

**Light**

Visible radiation (400 nm to 700–780 nm). For the purposes of this bulletin, limited to wavelengths between 400 and 700 nm.

**Micrometer ( $\mu m$ )**

Formerly termed *micron*, a measure of length equal to  $10^{-6}$  m.

**Nanometer (nm)**

Unit of length equal to  $10^{-9}$  m.

**Nominal Ocular Hazard Distance (NOHD)**

The NOHD is the distance from the operating laser at which the radiant exposure or irradiance within the beam equals the applicable exposure limit.

**Ocular Surveillance Examination**

A professional eye evaluation performed by an ophthalmologist, optometrist, or physician skilled in funduscopy and biomicroscopy of the eye.

**Open Installation**

Any location where lasers are used that will be open to operating personnel during laser operation, and may or may not specifically restrict entry to casuals.

**Optical Density (OD)**

A logarithmic expression for the attenuation produced by an attenuating medium, such as an eye protection filter.

$$OD = \log_{10} \Phi_o / \Phi_t$$

Where  $\Phi_o$  is the incident power and  $\Phi_t$  is the transmitted power at a specific wavelength.

**Optically Pumped Lasers**

A type of laser that derives energy from another optical radiation source such as a xenon flash lamp (coherent light sources have also been used).

**Point Source of Optical Radiation**

Ideally, a source with infinitesimal dimensions. Practically, a source of radiation whose dimensions are small compared with the viewing distance. For this guide, a source which subtends an angle at the viewer less than minutes.

**Pulse Duration**

Duration of a pulsed laser flash; it may be measured in terms of milliseconds ( $ms = 10^{-3}$  s), microseconds ( $\mu sec = 10^{-6}$  s), or nanoseconds ( $ns = 10^{-9}$  s). The time interval between the half-peak-power points on the leading and trailing edges of the pulse.

**Pulsed Laser**

A laser that delivers its energy in short pulses, as distinct from a CW laser. For the purposes of this bulletin, a laser that emits for less than 0.25 s.

**Quantum Mechanics**

Branch of science dealing with atomic and subatomic particles.

**Q-switched Laser**

A laser capable of extremely high peak powers for very short durations (pulse duration of several nanoseconds). A laser with a pulse width between 1 ns and 18  $\mu s$ .

**Radian**

A unit of angular measure equal to the angle subtended at the center of a circle by an arc whose length



is equal to the radius of the circle.

One (1) radian = 57.3 Degrees

Or  $2\pi$  radians = 360 Degrees

**Radiance (L)**

Radiant flux (radiant power) output per unit solid angle per unit area  $W\cdot cm^{-2}\cdot sr^{-1}$ ; radiometric brightness.

**Radiant Energy (Q)**

Energy in the form of electromagnetic waves usually expressed in units of joules (watt-seconds). Commonly used to describe the output of pulsed lasers.

**Radiant Exposure (H)**

The energy per unit area incident upon a given surface in a given time interval. It is used to express exposure dose to pulsed laser radiation and is commonly expressed in  $J\cdot cm^{-2}$ .

**Radiant Power ( $\Phi$ )**

The time rate of flow of radiant energy. Units of watts. Commonly used to describe the output of CW lasers or the average radiant output power of repetitively-pulsed lasers.

**Radiant Intensity (I)**

Radiant power in a given direction. Radiant flux emitted from the source per unit solid angle (steradian), in the direction of propagation, usually expressed in  $W\cdot sr^{-1}$ .

**Reflectance or Reflectivity ( $\rho$ )**

The ratio of reflected radiant flux to incident radiant flux.

**Repetitively Pulsed Laser**

A pulsed laser with reoccurring pulsed output. The frequency of the pulses is termed pulse repetition frequency (PRF). Repetitively pulsed lasers have properties similar to CW lasers if the PRF or duty cycle is very high.

**Scintillation**

In laser work, this term is frequently used to describe the effect upon a laser beam by atmospheric turbulence.

**Scotoma**

Loss of vision in part of the visual field; blind spot.

**Semiconductor or Injection Diode Laser**

A class of lasers that produces relatively low average power outputs.

**Shall**

Indicates a requirement that is necessary or essential to meet the currently accepted standards of protection or Federal rules and regulations.

**Should**

Indicates an advisory recommendation that is to be applied when practicable.

**Solid Angle ( $\Omega$ )**

The ratio of the area on the surface of a sphere to the square of the radius of that sphere. It is expressed in steradians (sr).

**Specular or Regular Reflection**

A mirror-like reflection.

**Steradian (sr)**

The unit of measure for a solid angle. There are 4 steradians in a sphere.

**Transmittance or Transmissivity ( $\tau$ )**

The ratio of total transmitted radiant power to total incident radiant power.

**Ultraviolet Radiation**

Electromagnetic radiation with wavelengths between soft X-rays and visible, violet light. This region is often broken down into three spectral bands by wavelength: UV-A (315 to 400 nm), UV-B (280 to 315 nm), and UV-C (200 to 280 nm).

**Visible Radiation (light)**

Electromagnetic radiation that can be detected by the human eye. It is commonly used to describe wavelengths that lie in the range between 400 nm and 700–780 nm. For the purposes of this bulletin, it is limited to wavelengths between 400 and 700 nm.

**Vision screening examination**

A battery of visual tests which may be accomplished by a trained technician. The testing is generally done with a stereoscopic type instrument for measuring visual acuity, phorias, stereopsis, and color perception.

**Watt (W)**

The unit of power or radiant flux; 1 joule-per-second. Used principally with CW lasers.

**Watt $\cdot cm^{-2}$  ( $W\cdot cm^{-2}$ )**

A unit of irradiance used in measuring the amount of power-per-area of absorbing surface, or per cross-sectional area of a CW laser beam.

**Wavelength ( $\lambda$ )**

The distance between two points in a periodic wave that have the same phase is termed 1 wavelength. The velocity of light ( $3 \times 10^{10}$  cm/s) divided by frequency (in Hz) equals wavelength (in cm).

The proponent agency of this bulletin is the Office of The Surgeon General. Users are invited to send comments and suggested improvements on DA Form 2028 (Recommended Changes to Publications and Blank Forms) direct to HQDA (DASG-PSP), WASH DC 20310-2300.

By Order of the Secretary of the Army:

Official:

DONALD J. DELANDRO  
*Brigadier General, United States Army*  
*The Adjutant General*

JOHN A. WICKHAM, JR.  
*General, United States Army*  
*Chief of Staff*

Distribution:

*Active Army, ARNG, USAR:* To be distributed in accordance with DA Form 12-34C requirements for TB MED Series: Professional Medical Material.